



2014 Catalog





Over 40 years ago, Prestige Medical pioneered the concept of pairing diagnostic medical instruments and nursing accessories with medical apparel in retail uniform stores across the United States.

Today, Prestige Medical has built a reputation of excellence with nurses, students, and other healthcare professionals in the U.S. and globally as we have expanded our innovative personalization of healthcare instruments concept to six continents. A relentless focus on stethoscopes, aneroid sphygmomanometers, pulse oximeters, digital blood pressure monitors, medical apparel, medical tools, and nursing accessories makes Prestige Medical the industry leader in outfitting medical professionals.



Cathi Eicher
Director, Uniform Sales



Seth Sternberger
Director, DME Sales



Joshua Caudillo
Sales



Kevin Ramirez
Sales Support



Vanessa Valdes
New Accounts Specialist



Maribel Solano
Manager, Customer Service

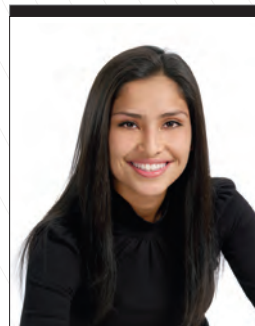

Meilanie Guerrero
Reception



Carol Bilderbach
Customer Service

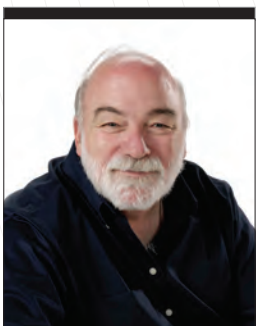

Ed Fryinger
Customer Service



Jamie Amato
Customer Service / ASI



Erika Zamudio
Customer Service

Diagnostics & Instruments

- 2** Stethoscopes
- 24** 3M Littmann®
- 28** Aneroid Sphygmomanometers
- 36** Combination Kits
- 42** Prestige Basics
- 45** Veterinary Products
- 46** Home Healthcare
- 50** Diagnostic Instruments
- 54** EMS Products
- 60** Scissors & Instruments

- 62** Apparel & Accessories





STETHOSCOPES

Why are there so many stethoscopes to choose from and what makes some stethoscopes better than others? Generally speaking, there are three main design features of a stethoscope which impacts its performance.

e Eartips

The eartip is critical to the optimal performance of a stethoscope. It's designed to conform to the outer ear canal to seal out extraneous sound. However, each individual has differences in the size and shape of their ear canals. By following these design requirements, Prestige Medical has developed two sizes of soft silicone eartips for Clinical Series stethoscopes. Silicone provides superior softness, conformability, and resists exposure to chemicals and oils. Prestige Medical also provides soft PVC eartips for most other stethoscopes to enhance their performance and comfort.

t Tubing

Stethoscope tubing is designed to transfer acoustic sound waves channeled by the stethoscope's diaphragm and bell to the practitioner during auscultation. The thickness of the tube is an important factor in enhancing the efficiency of sound transference. Thicker stethoscope tubing transfers sound waves more efficiently while minimizing acoustic interference from the ambient environment. Most Prestige Medical stethoscopes incorporate thick walled tubing to help deliver optimal performance.

m Metal

There are three metals from which most Prestige Medical stethoscopes are constructed. Stainless steel is an alloy prized for its durability and resistance to corrosion, rust, and staining. It is also an excellent metal for the transference of sound waves. Aluminum is very light weight and economical and that lends a significant functionality benefit to those who prefer the convenience of a lighter weight instrument. Zinc is excellent for manufacturing complex stethoscope parts economically such as the Sprague-Rappaport chestpiece while still providing very good acoustic characteristics.

Anatomy of a Stethoscope

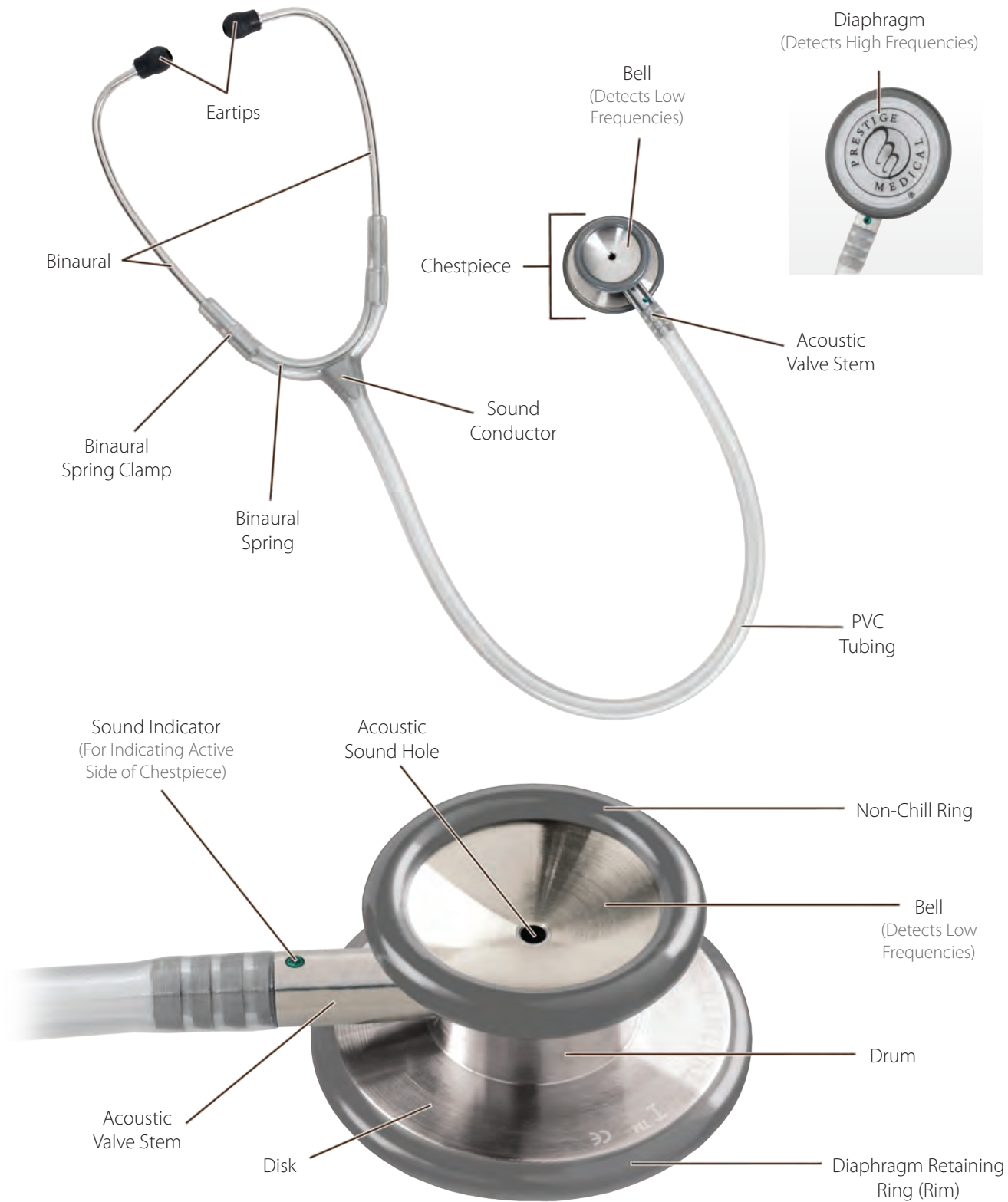

THE CLINICAL SERIES

Two Piece Box

- ID Tag Included
- Extra Eartips Included
- User Manual & Warranty

The Clinical Series Warranty

All Clinical Series stethoscopes feature a Lifetime Warranty with Free Lifetime Replacement Parts.

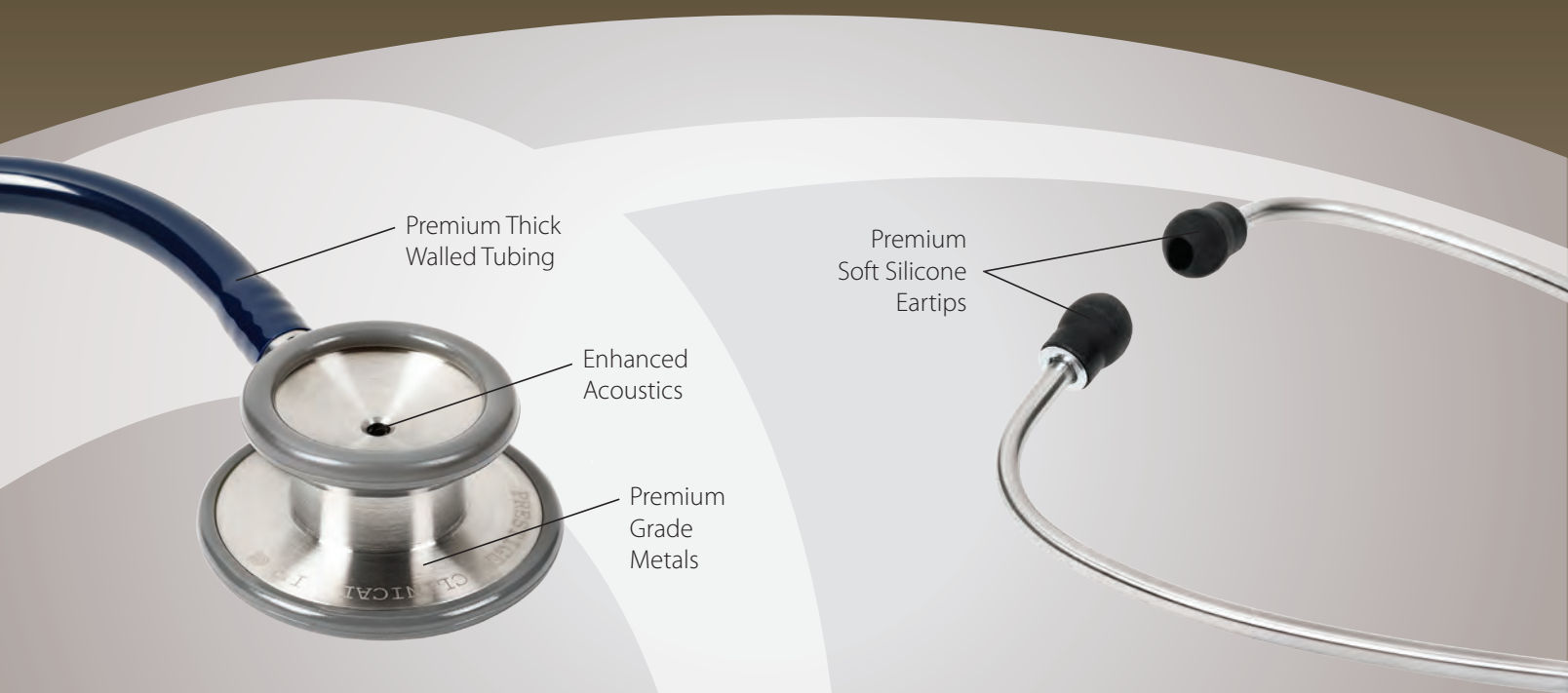



Clinical Cardiology®

Model : 128 (Box)

- Enhanced traditional stainless steel cardiology stethoscope
- Includes pediatric diaphragm assembly and interchangeable adult bell
- 2-in-1 tube configuration for optimal sound transference
- Fiberglass diaphragm is used to hear higher frequency heart and respiratory sounds
- Stainless steel bell is used to hear lower frequency heart sounds
- Lifetime Warranty with Free Lifetime Replacement Parts



Navy

eartips Soft Silicone

tubing 2-in-1 Thick Walled PVC

metal Stainless Steel

Accessories Included	Two sizes of soft eartips, Replacement diaphragm, Bell and diaphragm assembly
-----------------------------	---

Overall Length	Appx. 27"*
-----------------------	------------

Weight	Appx. 7.0 oz*
---------------	---------------

Ideal For	Cardiologists Respiratory Specialists General Practitioners Internists ER Medical Students EMTs
------------------	---

** Due to the handmade craftsmanship and material attributes, actual specifications may vary*

Tube Colors - Solid:





Clinical Classic®

Model : 127 (Box)

- Ergonomically designed single sided chestpiece for easy manipulation during auscultation
- 2-in-1 tube configuration for optimal sound transference
- Snap-on fiberglass diaphragm is used to hear a wide range of frequencies
- Ideal for a wide range of auscultation diagnostics
- Lifetime Warranty with Free Lifetime Replacement Parts



Purple

eartips Soft Silicone

tubing Thick Walled PVC

metal Zinc

Accessories Included	Two sizes of soft eartips, Replacement diaphragm
Overall Length	Appx. 27"*
Weight	Appx. 7.0 oz*
Ideal For	Cardiologists Respiratory Specialists General Practitioners Internists ER Medical Students

** Due to the handmade craftsmanship and material attributes, actual specifications may vary*

Tube Colors - Solid:





Clinical I®

Models : 126 (Box), S126 (Clamshell)

- A classic dual head stethoscope enhanced with all-stainless steel construction
- Fiberglass diaphragm side is used to hear S1 and S2 heart sounds and Korotkoff sounds
- Bell side is used to hear S3 and S4 heart sounds
- Excellent for all higher level auscultation diagnostics
- Lifetime Warranty with Free Lifetime Replacement Parts



Neon Blue

eartips Soft Silicone

tubing Thick Walled PVC

metal Stainless Steel

Accessories Included	Two sizes of soft eartips, Replacement diaphragm
Overall Length	Appx. 31"*
Weight	Appx. 5.8 oz*
Ideal For	General Practitioners Critical Care Nurses Internists Medical Students ER EMTs

* Due to the handmade craftsmanship and material attributes, actual specifications may vary

Tube Colors - Solid:

BLK Black	HPK Hot Pink	HUN Hunter	NAV Navy	PAC Pacific
PUR Purple	RED Red	ROY Royal	STE Stealth	

Tube Colors - Neon:

N-BLU Neon Blue	N-GRN Neon Green	N-ORG Neon Orange	N-PNK Neon Pink	N-YEL Neon Yellow



Clinical I® - Pediatric Edition

Model : 126-PED (Box)

- The Clinical I® stethoscope chestpiece is sized to be acoustically precise for diagnostic use with children
- Lifetime Warranty with Free Lifetime Replacement Parts



eartips Soft Silicone

tubing Thick Walled PVC

metal Stainless Steel

Accessories Included: Two sizes of soft eartips, replacement diaphragm

Overall Length: Appx. 31"*

Weight: Appx. 4.5 oz*

Ideal For: Pediatricians, General Practitioners, Critical Care Nurses, Internists, Medical Students, ER, EMTs

** Due to the handmade craftsmanship and material attributes, actual specifications may vary*

Tube Color - Solid:



BLK
Black



Clinical I® - Infant Edition

Model : 126-INF (Box)

- The Clinical I® stethoscope chestpiece is sized to be acoustically precise for diagnostic use with infants
- Lifetime Warranty with Free Lifetime Replacement Parts



eartips Soft Silicone

tubing Thick Walled PVC

metal Stainless Steel

Accessories Included: Two sizes of soft eartips, replacement diaphragm

Overall Length: Appx. 31"*

Weight: Appx. 3.9 oz*

Ideal For: Pediatricians, General Practitioners, Critical Care Nurses, Internists, Medical Students, ER, EMTs

** Due to the handmade craftsmanship and material attributes, actual specifications may vary*

Tube Color - Solid:



BLK
Black



Clinical I® - Gold Edition

Model : 126-G (Box)

- The all-stainless steel construction is enhanced with 22K gold plating
- Lifetime Warranty with Free Lifetime Replacement Parts



eartips

Soft Silicone

tubing

Thick Walled PVC

metal

22K Gold Plated Stainless Steel

Accessories Included: Two sizes of soft eartips, replacement diaphragm
Overall Length: Appx. 31"*
Weight: Appx. 5.8 oz*
Ideal For: General Practitioners, Critical Care Nurses, Internists, Medical Students, ER, EMTs

** Due to the handmade craftsmanship and material attributes, actual specifications may vary*

Tube Color - Solid:



BLK
Black



Clinical I® - Teaching Edition

Model : 126-T (Box)

- The Clinical I® stethoscope is integrated into two binaural headsets to permit dual auscultation between instructor and student
- Lifetime Warranty with Free Lifetime Replacement Parts



eartips

Soft Silicone

tubing

Thick Walled PVC

metal

Stainless Steel

Accessories Included: Two sizes of soft eartips, replacement diaphragm
Overall Length: Appx. 45"*
Weight: Appx. 8.7 oz*
Ideal For: Instructors, Students

** Due to the handmade craftsmanship and material attributes, actual specifications may vary*

Tube Color - Solid:



BLK
Black



Clinical Lite™

Models : 121 (Box), S121 (Clamshell)

- A classic dual head stethoscope enhanced by light weight anodized aluminum construction
- Fiberglass diaphragm side is used to hear S1 and S2 heart sounds and Korotkoff sounds
- Bell side is used to hear S3 and S4 heart sounds
- Weighs just 3.9 oz*
- Lifetime Warranty with Free Lifetime Replacement Parts



Neon Pink

eartips Soft Silicone

tubing Thick Walled PVC

metal Aluminum

Accessories Included Two sizes of soft eartips
Replacement diaphragm

Overall Length Appx. 31"*

Weight Appx. 3.9 oz*

Ideal For General Practitioners
Nurses
Nursing Students
Medical Students
EMTs

** Due to the handmade craftsmanship and material attributes, actual specifications may vary*

Tube Colors - Solid:



Tube Colors - Neon:





Clinical Stereo™

Model : 131 (Box)

- Revolutionary dual chamber chestpiece and tube design enables true stereo auscultation
- Exceptional sound volume and clarity
- Fiberglass diaphragm is used to hear higher frequency heart and respiratory sounds
- U.S. Patent #D625804
- Lifetime Warranty with Free Lifetime Replacement Parts

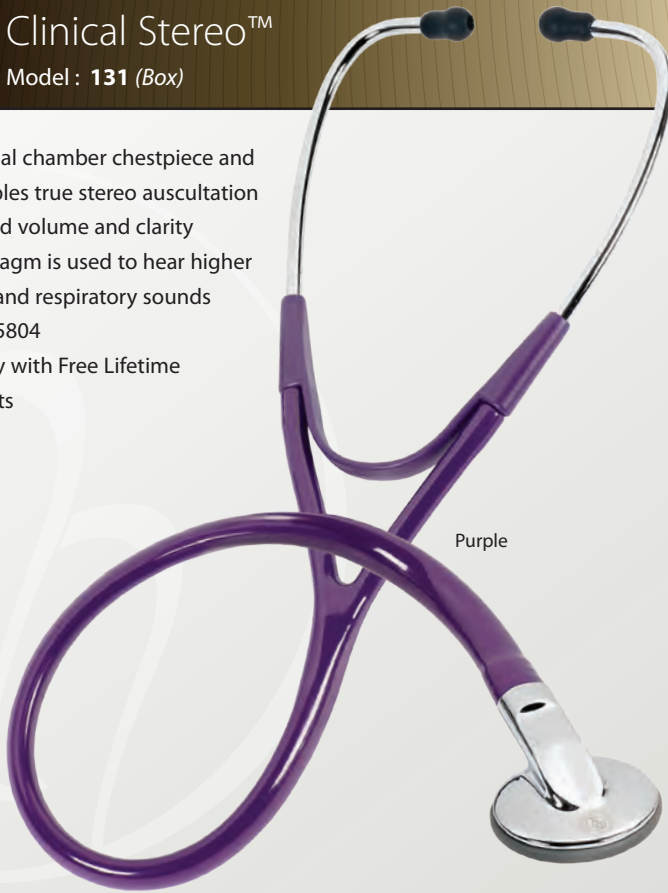

Purple

eartips Soft Silicone

tubing 2-in-1 Thick Walled PVC

metal Zinc

Accessories Included: Two sizes of soft eartips, replacement diaphragm

Overall Length: Appx. 27"*

Weight: Appx. 5.4 oz*

Ideal For: Cardiologists, Respiratory Specialists, General Practitioners, Internists, ER

* Due to the handmade craftsmanship and material attributes, actual specifications may vary

Tube Colors - Solid:

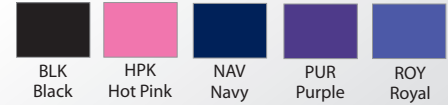

Clinical Sprague™

Model : 120 (Box)

- Emulates the design of the classic HP Rappaport-Sprague stethoscope
- Specially designed air-filled latex eartips provide extraordinary comfort and sound sealing ability
- Interchangeable bells with form fitted non-chill sleeves for enhanced patient comfort
- Lifetime Warranty with Free Lifetime Replacement Parts

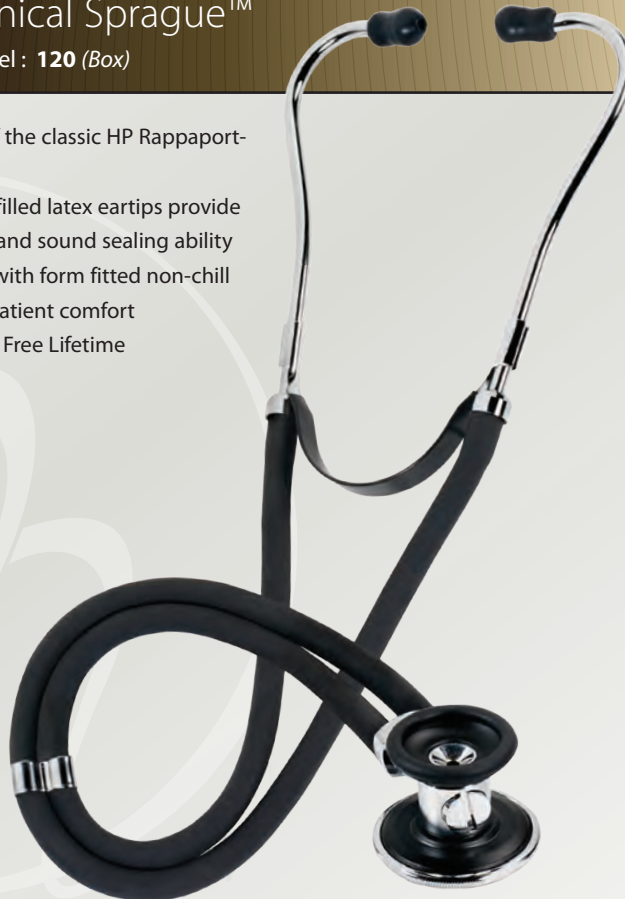

eartips Air Filled Latex

tubing Dual Thick Walled PVC

metal Zinc

Accessories Included: Firm PVC eartips, adult and pediatric diaphragms, infant and pediatric bells, pediatric diaphragm assembly, disc key

Overall Length: Appx. 24"*

Weight: Appx. 7.3 oz*

Ideal For: General Practitioners, Internists, Nurses, ER, Medical Students, EMTs

* Due to the handmade craftsmanship and material attributes, actual specifications may vary

Tube Color - Solid:



American
innovation
since 1969



Sprague-Rappaport Stethoscope

Models : **122** (Box), **S122** (Clamshell)

- The most widely used stethoscope in the healthcare industry
- 5-in-1 design enables use with adult, pediatric, and infant patients
- Full accessory pouch included
- Lifetime Warranty with Free Lifetime Replacement Parts

 Soft PVC

 Dual Thick Walled PVC

 Zinc

Accessories Included: Soft PVC eartips, adult and pediatric diaphragms, pediatric disc and diaphragm assembly, pediatric and infant bells

Overall Length: Appx. 30"*

Weight: Appx. 7.2 oz*

Ideal For: General Practitioners, Nurses, Nursing / Medical Students, ER, EMTs

** Due to the handmade craftsmanship and material attributes, actual specifications may vary*

Tube Colors - Solid:

			
BLK Black	BUR Burgundy	CBL Ciel	GBL Galaxy Blue
			
GRY Grey	HOR Hot Orange	HPK Hot Pink	HUN Hunter
			
NAV Navy	PAC Pacific	PAS Passion	PUR Purple
			
RED Red	ROY Royal	TEA Teal	STE Stealth

Tube Colors - Neon:

		
N-BLU Neon Blue	N-GRN Neon Green	N-ORG Neon Orange
		
N-PNK Neon Pink	N-YEL Neon Yellow	

Tube Colors - Frosted:

	
F-KIW Kiwi	F-PUR Purple

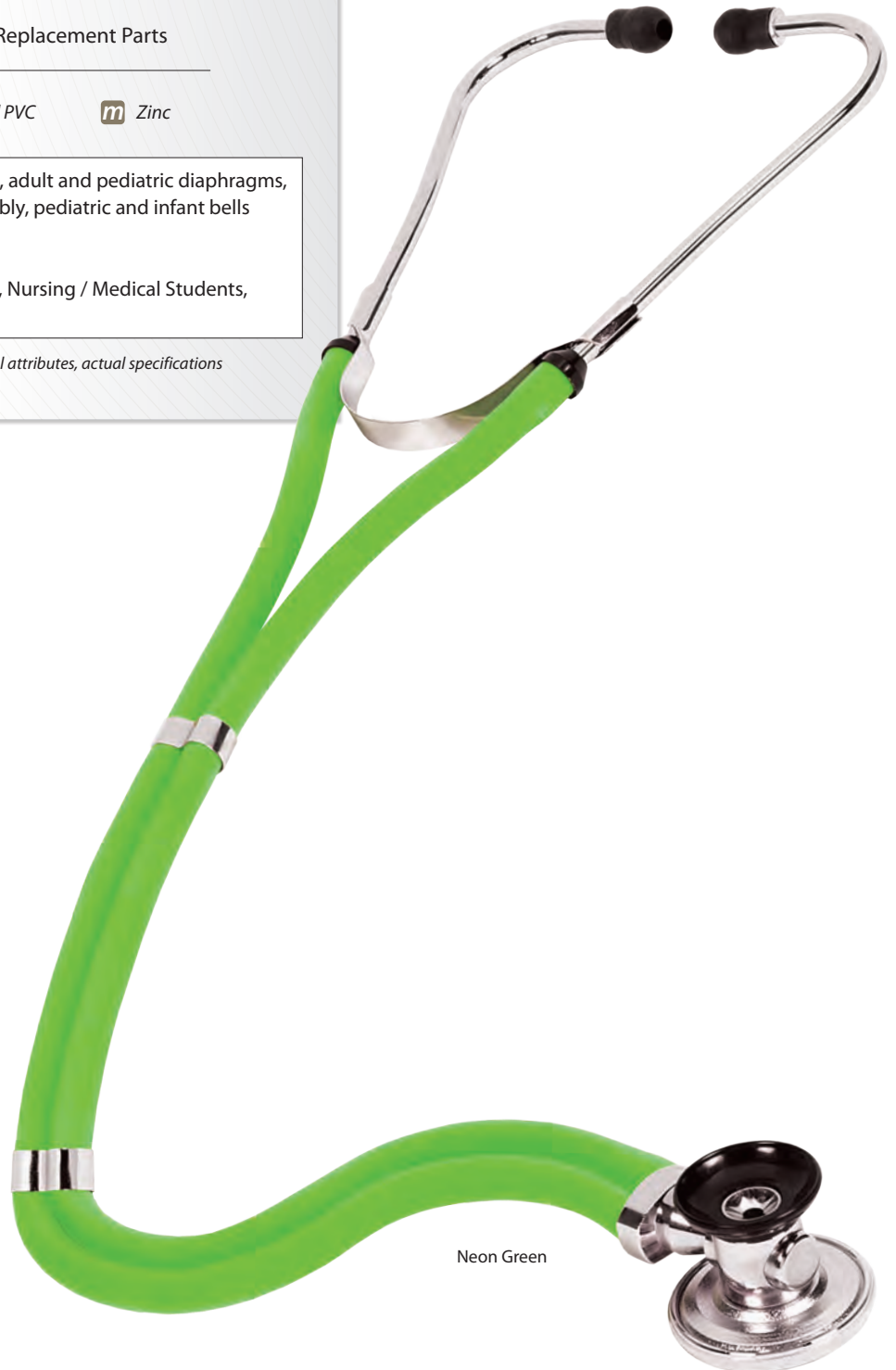

Neon Green

Sprague-Rappaport - Gold Edition

Model : **122-G** (Box)

- The Sprague-Rappaport stethoscope is enhanced with 22K gold plating
- Full accessory pouch included
- Lifetime Warranty with Free Lifetime Replacement Parts

e Soft PVC

t Dual Thick Walled PVC

m 22K Gold Plated Zinc

Accessories Included: Soft PVC eartips, adult and pediatric diaphragms, pediatric disc and diaphragm assembly, pediatric and infant bells

Overall Length: Appx. 30"*

Weight: Appx. 7.2 oz*

Ideal For: General Practitioners, Nurses, Nursing / Medical Students, ER, EMTs

* Due to the handmade craftsmanship and material attributes, actual specifications may vary

Tube Color - Solid:



BLK
Black

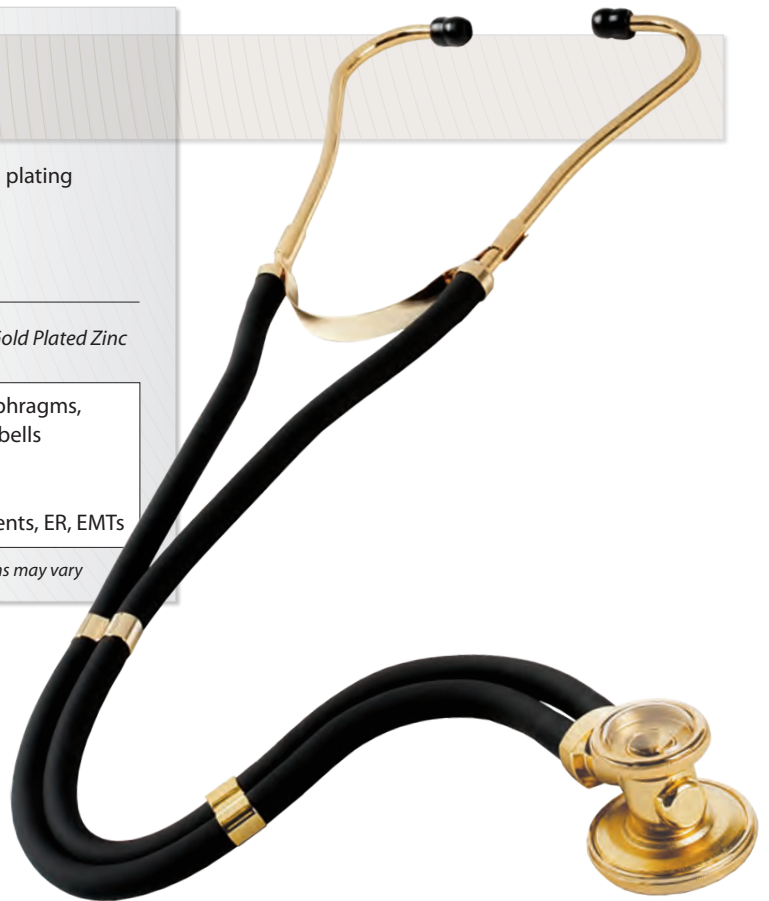

Sprague-Rappaport - Teaching Edition

Model : **S122-T** (Clamshell)

- Incorporates a standard Sprague-Rappaport chestpiece and two separate tube and binaural sets
- Excellent for instructors to teach students the finer points of auscultation
- Full accessory pouch included
- Lifetime Warranty with Free Lifetime Replacement Parts

e Soft PVC

t Dual Thick Walled PVC

m Zinc

Accessories Included: Soft PVC eartips, adult and pediatric diaphragms, pediatric disc and diaphragm assembly, pediatric and infant bells

Overall Length: Appx. 31.5"*

Weight: Appx. 8.3 oz*

Ideal For: Nursing Instructors, Students

* Due to the handmade craftsmanship and material attributes, actual specifications may vary

Tube Color - Solid:



BLK
Black

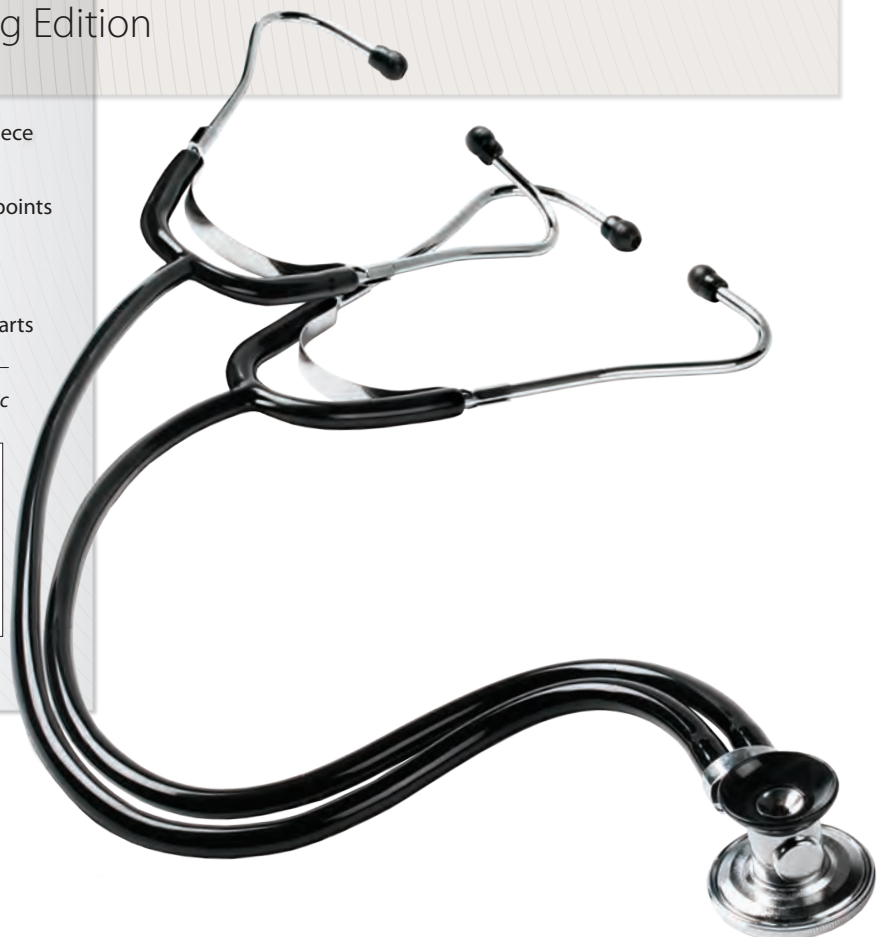

SpragueLite®

Models : **124** (Box), **S124** (Clamshell)

- All the best features of the traditional Sprague-Rappaport, but with significantly less weight
- Versatile 5-in-1 design enables use with adult, pediatric, and infant patients
- Full accessory pouch included
- U.S. Patent #D390660
- Lifetime Warranty with Free Lifetime Replacement Parts



Soft PVC



Thick Walled PVC



Zinc

Accessories Included: Soft PVC eartips, adult and pediatric diaphragms, pediatric disc and diaphragm assembly, pediatric and infant bells

Overall Length: Appx. 32"*

Weight: Appx. 4.9 oz*

Ideal For: General Practitioners, Nurses, Nursing / Medical Students, ER, EMTs

** Due to the handmade craftsmanship and material attributes, actual specifications may vary*

Tube Colors - Solid:



BLK
Black



BUR
Burgundy



CBL
Ciel



HPK
Hot Pink



HUN
Hunter



NAV
Navy



PUR
Purple



RED
Red



ROY
Royal



STE
Stealth

Tube Colors - Neon:



N-BLU
Neon
Blue



N-GRN
Neon
Green



N-ORG
Neon
Orange



N-PNK
Neon
Pink



N-YEL
Neon
Yellow

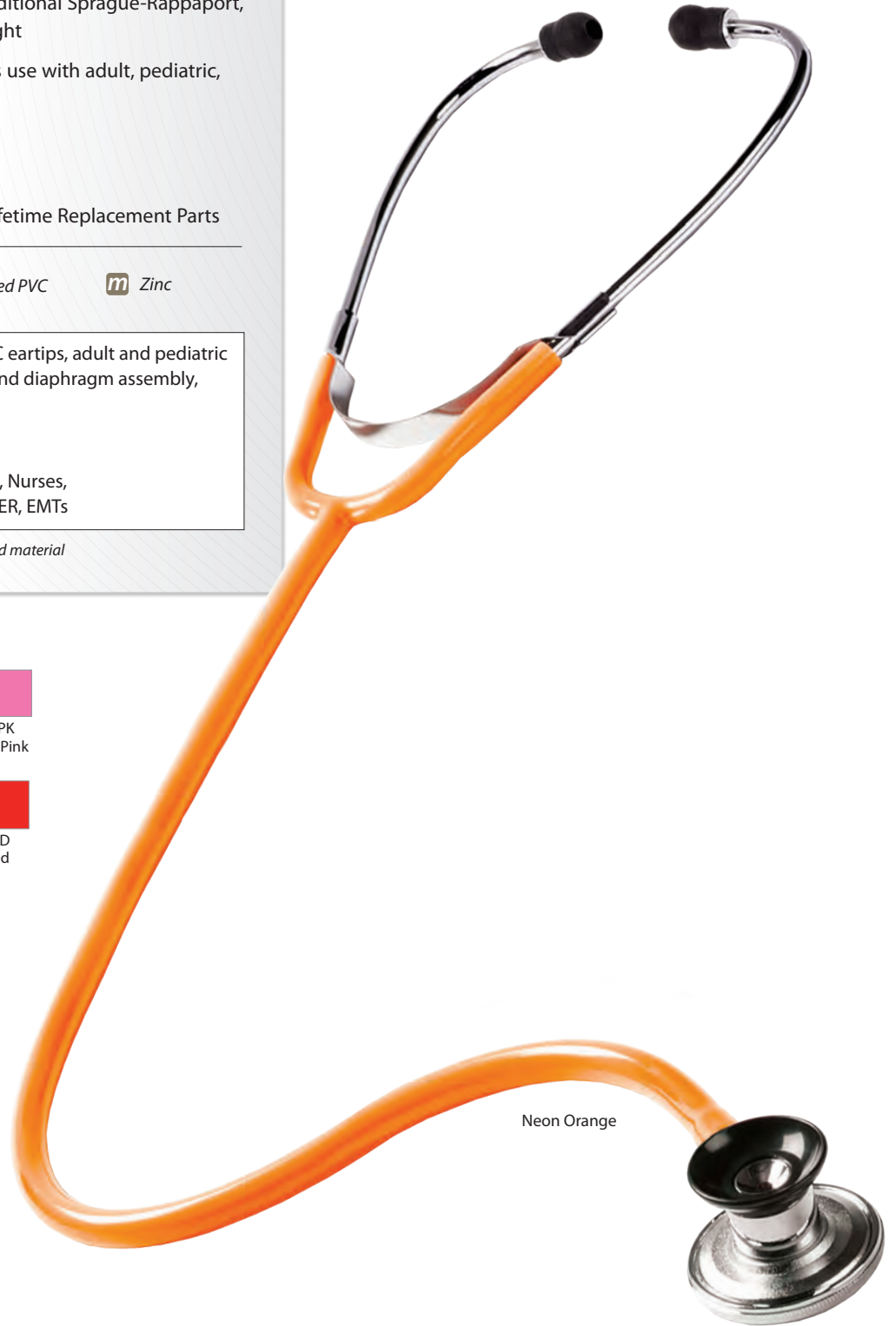

Clear Sound™

Model: **S107** (Clamshell)

- Ultra-sensitive acoustics
- Accurate assessment through up to 10 layers of folded towels
- Chestpiece made from impact-resistant acrylic resin
- Lifetime Warranty with Free Lifetime Replacement Parts

e Soft PVC

t Thick Walled PVC

m Acrylic Resin

Accessories Included: Soft PVC eartips, ID tag
Overall Length: Appx. 30"*
Weight: Appx. 4.2 oz*
Ideal For: Nurses

* Due to the handmade craftsmanship and material attributes, actual specifications may vary

Tube Colors - Solid:



BLK
Black



HPK
Hot Pink



PLU
Plum

Tube Colors - Frosted:



F-GLA
Glacier



F-PUR
Purple



F-ROY
Royal

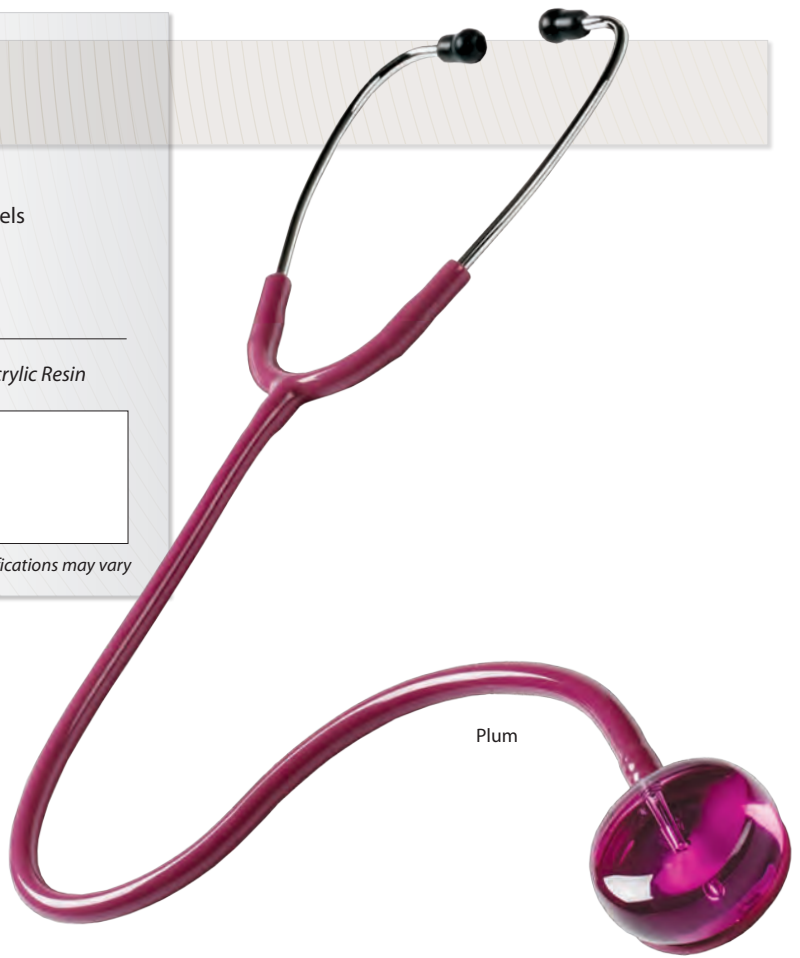

Plum

Clear Sound™ - Breast Cancer Awareness Edition

Model: **S107-PR** (Clamshell)

- All the same features as the standard Clear Sound
- Unique Pink Ribbon imprinted inside the chestpiece
- A portion of the sales of this stethoscope is donated to the American Cancer Society
- Lifetime Warranty with Free Lifetime Replacement Parts

e Soft PVC

t Thick Walled PVC

m Acrylic Resin

Accessories Included: Soft PVC eartips, ID tag
Overall Length: Appx. 30"*
Weight: Appx. 4.2 oz*
Ideal For: Nurses

* Due to the handmade craftsmanship and material attributes, actual specifications may vary



Clear Sound™ - Heart Edition

Model : **S107-H** (Clamshell)

- All the same features as the standard Clear Sound
- Unique heart-shaped chestpiece
- Patent #D566837
- Lifetime Warranty with Free Lifetime Replacement Parts



Soft PVC



Thick Walled PVC



Acrylic Resin

Accessories Included: Soft PVC eartips, ID tag

Overall Length: Appx. 31"*

Weight: Appx. 4.5 oz*

Ideal For: Nurses

** Due to the handmade craftsmanship and material attributes, actual specifications may vary*

Tube Color - Solid:



Red with Black

Tube Colors - Frosted:



F-PUR
Purple



F-ROY
Royal



Red with Black

Clear Sound™ - Printed Edition

Model : **S107** (Clamshell)

- All the same features as the standard Clear Sound
- Designs imprinted inside the chestpiece
- Lifetime Warranty with Free Lifetime Replacement Parts



Soft PVC



Thick Walled PVC



Acrylic Resin

Accessories Included: Soft PVC eartips, ID tag

Overall Length: Appx. 30"*

Weight: Appx. 4.2 oz*

Ideal For: Nurses

** Due to the handmade craftsmanship and material attributes, actual specifications may vary*

Black Tubes - Prints:



SML
Smiley Face



LUV
Betty Boop®
LUV-A-NURSE



Dual Head Stethoscope

Models : **108** (Box), **S108** (Clamshell)

- Traditional aluminum dual head stethoscope
- Lifetime Warranty with Free Lifetime Replacement Parts

e Soft Silicone **t** Standard PVC **m** Aluminum

Accessories Included: Soft PVC eartips
Overall Length: Appx. 32"*
Weight: Appx. 3.8 oz*
Ideal For: General Practitioners, Nurses, Nursing Students

* Due to the handmade craftsmanship and material attributes, actual specifications may vary

Tube Colors - Solid:

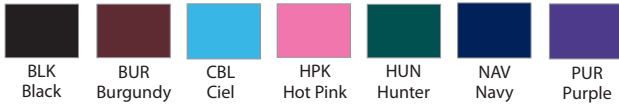

Tube Colors - Neon:



Ciel

Dual Head - Pediatric Edition

Model : **S108-P** (Clamshell)

- The traditional dual head stethoscope is sized to be acoustically precise for diagnostic use with children
- Lifetime Warranty with Free Lifetime Replacement Parts

e Soft Silicone **t** Standard PVC **m** Aluminum

Accessories Included: Soft PVC eartips
Overall Length: Appx. 31.5"*
Weight: Appx. 3.5 oz*
Ideal For: Pediatricians

* Due to the handmade craftsmanship and material attributes, actual specifications may vary

Tube Colors - Solid:

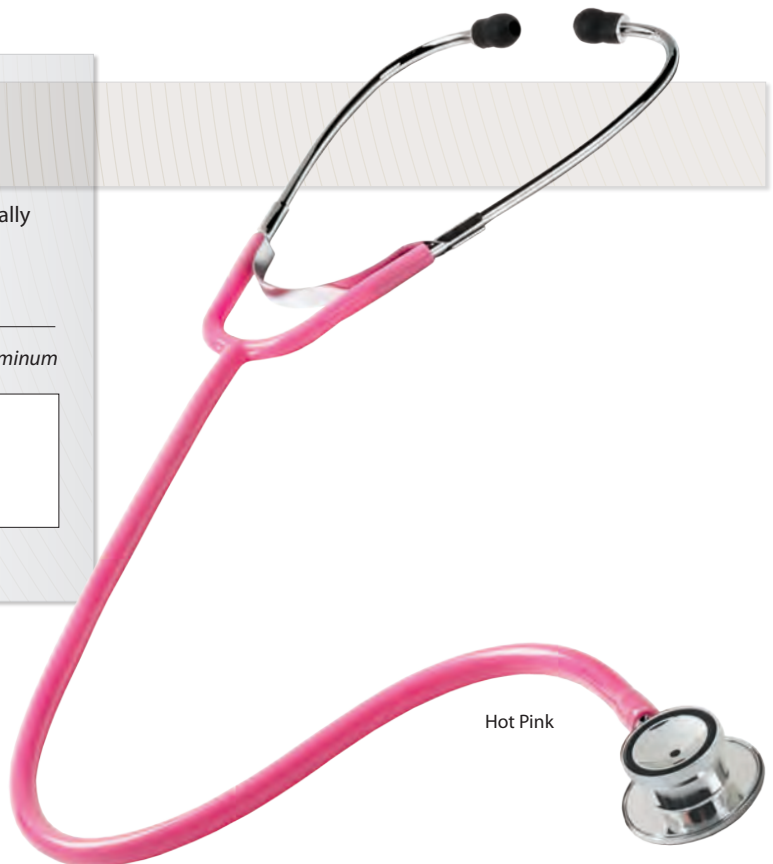
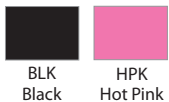

Hot Pink

Ultra-Sensitive Dual Head Stethoscope

Model : **S125** (Clamshell)

- Traditional dual head design incorporating an ultra-sensitive random fiber diaphragm
- Enhanced zinc chestpiece and thick walled tubing
- Lifetime Warranty with Free Lifetime Replacement Parts

e Soft Silicone

t Thick Walled PVC

m Zinc

Accessories Included: Soft PVC eartips

Overall Length: Appx. 32"*

Weight: Appx. 5.1 oz*

Ideal For: General Practitioners, Nurses, Nursing / Medical Students

** Due to the handmade craftsmanship and material attributes, actual specifications may vary*

Tube Colors - Solid:



Tube Colors - Neon:

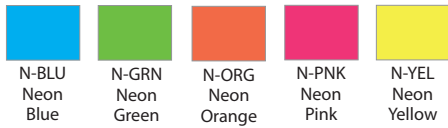

Dual Head - Infant Edition

Model : **S108-I** (Clamshell)

- The traditional dual head stethoscope is sized to be acoustically precise for diagnostic use with Infants
- Lifetime Warranty with Free Lifetime Replacement Parts

e Soft Silicone

t Standard PVC

m Aluminum

Accessories Included: Soft PVC eartips

Overall Length: Appx. 31.5"*

Weight: Appx. 3.5 oz*

Ideal For: Pediatricians

** Due to the handmade craftsmanship and material attributes, actual specifications may vary*

Tube Colors - Solid:

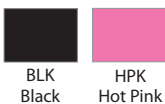

Single Head Stethoscope

Models : **106** (Box), **S106** (Clamshell)

- Ergonomically designed lightweight aluminum chestpiece
- Designed to fit under the cuff during blood pressure assessment or for basic diagnostics
- Lifetime Warranty with Free Lifetime Replacement Parts

e Soft Silicone

f Standard PVC

m Aluminum

Accessories Included: Soft PVC eartips

Overall Length: Appx. 31.5"*

Weight: Appx. 2.8 oz*

Ideal For: Nurses, Nursing Students, Blood Pressure Measurement

* Due to the handmade craftsmanship and material attributes, actual specifications may vary

Tube Colors - Solid:



BLK
Black

HPK
Hot Pink

NAV
Navy

PUR
Purple

ROY
Royal



Royal

Single Patient Stethoscope

Model : **100** (Poly Bag)

- Disposable stethoscope designed for single patient use
- Prevents cross-contamination
- Yellow tubing only

e Firm PVC

f Standard PVC

m Plastic

Accessories Included: None

Overall Length: Appx. 30"*

Weight: Appx. 1.9 oz*

Ideal For: General Assessment in cross-contamination hazard or quarantine conditions

* Due to the handmade craftsmanship and material attributes, actual specifications may vary

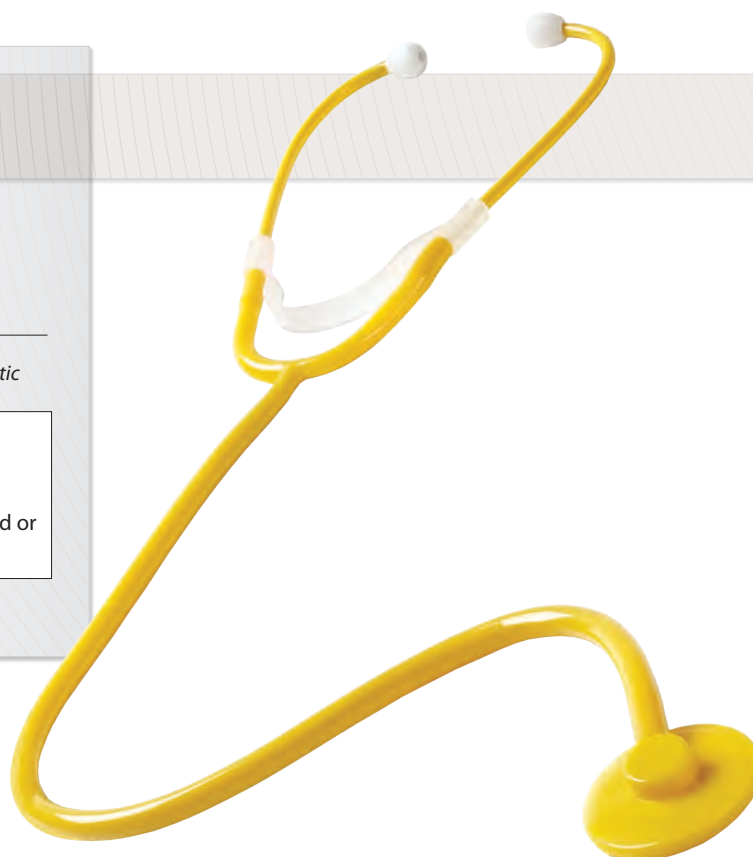

Stethoscope Tape Holder

Model : **754** (Slide Pack)

- Attaches to any stethoscope
- Keeps a roll of 1" medical tape handy
- A perfect counter-weight to help balance the stethoscope around the user's neck
- Made in the U.S.A.



Pink



Quick Equip™ Stethoscope Light

Model : **S205** (Slide Pack)

An LED light that snaps onto a stethoscope chestpiece.
Compatible with Prestige models 121, 126, 124, S134, 108, S125.

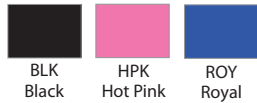

Royal



Stethoscope Watch

Model : **1688** (Slide Pack)

Back clip attaches to most stethoscope tubing. 24 hour face with step second hands. Quartz movement and a water resistant case. Includes an LR626 battery.



Medical Symbols Stethoscope Watch

Model : **1689** (Slide Pack)

Back clip attaches to most stethoscope tubing. 24 hour face with step second hands. Quartz movement and a water resistant case. Includes an LR626 battery.

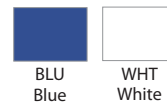

Hip Clip™ Stethoscope Holder

Model : **755** (Poly Bag)

A convenient stethoscope holder that affixes to the user's belt or waist band. Eliminates the fatigue of wearing a stethoscope around the neck.

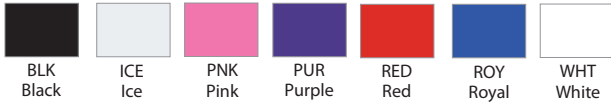

Printed Stethoscope ID Tag

Model : **S8** (Slide Pack)

Single-sided stethoscope ID tags featuring a "domed" printed face. A virtually indestructible adhesive closure enables secure attachment to any stethoscope tube.



BHB
Betty Boop®
Too Hot

CDN
Candy Nurse

BFY
Butterflies

PLN
Panda
(Love a Nurse)

FLN
Frog
(Love a Nurse)

PRH
Pink Ribbon
Hope*

Two-Sided ID Tag

Model : **S4** (Slide Pack)

Double-sided ID tag enables identification to be written on both sides. Universal fit.

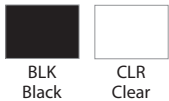

Sprague ID Tag

Model : **S7-CLR** (Slide Pack)

Single-sided ID Tag. Designed for the Sprague-Rappaport stethoscope.



REPLACEMENT PARTS

Prestige Replacement Parts



To view all of our stethoscope accessories and replacement parts, please visit:

www.prestigemedical.com

Push-On Eartips

Model : **DET-SN**

Soft push-on PVC eartips.

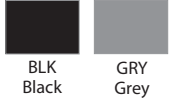

DET-SN-L - Large
DET-SN-S - Small

Fits:

S107
120
S121, 121
S126, 126
127
128
131

Clear PVC Clinical Eartips

Model : **CE-PVC**

Soft premium push-on PVC eartips.



Fits:

S121, 121
S126, 126
127
128

Silicone Clinical Eartips

Model : **CE-SIL**

Soft premium push-on silicone eartips.



CE-SIL-L - Large
CE-SIL-S - Small

Fits:

S121, 121
S126, 126
127
128

Clear Plastic Eartips

Model : **122-I-CET**

Clear PVC eartips.



Fits:

112
S122, 122
S124, 124

Soft Premium Eartips

Model : **DET-120**

Air-filled latex eartips.



DET-120 - Unpackaged
DET-S120 - Slide Pack

Fits:

120
S122, 122
S124, 124
131

Firm Plastic Eartips

Model : **122-I-ET**

Firm PVC eartips.

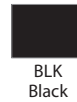

Fits:

S122, 122
S124, 124

Firm Plastic Eartips

Model : **ET**

Firm PVC eartips.



Fits:

S106, 106
S108, 108
S125

Threaded Eartips

Model : **DET-122**

Threaded soft PVC eartips.

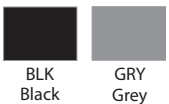

DET-122-L - Large
DET-122-S - Small

Fits:

112
S122, 122
S124, 124

Mushroom Eartips

Model : **S-SET**

Soft PVC eartips.



Fits:

S106, 106
S108, 108
S125

3100 ELECTRONIC

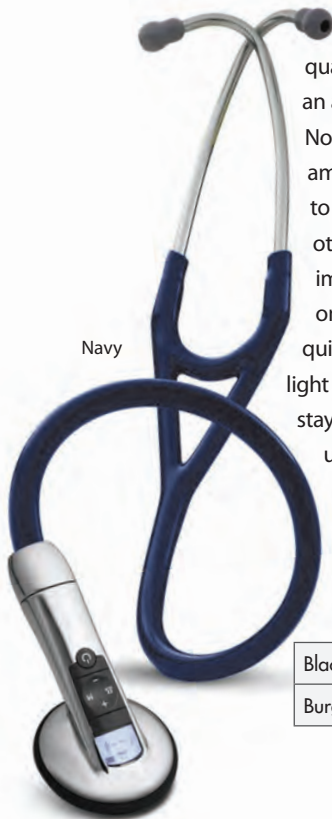

Navy

This model's exceptional sound quality reduces background noise an average of 85% with its Ambient Noise Reduction Technology and amplifies sounds up to 24 times to hear faint sounds you might otherwise miss. You can auscultate immediately, thanks to the instant-on technology. The power button quickly activates backlight for low-light conditions and the stethoscope stays in battery-saving "sleep mode" until you start your next auscultation. The backlit LCD display includes frequency selection, sound level, remaining battery life and your patient's heart rate.

Black - 3100BK27	Navy - 3100NB
Burgundy - 3100BU	

3200 ELECTRONIC

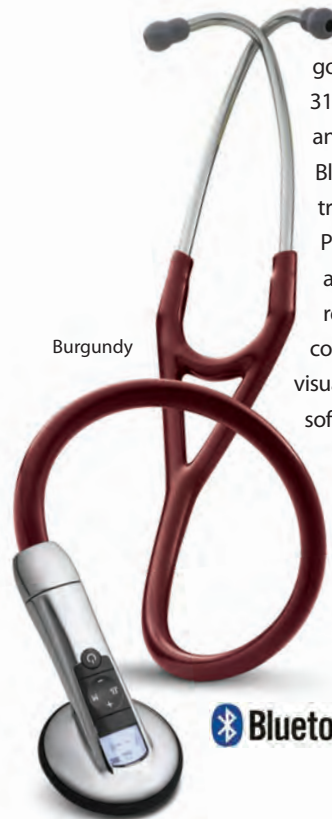

Burgundy

The Electronic Model 3200 goes even further than the Model 3100 - with on-board recording and playback capabilities. Also, Bluetooth® technology lets you transmit sounds real-time to your PC, which can then be further analyzed, attached to medical records, or reviewed online with colleagues. Free heart & lung sound visualization software, and available software that identifies suspected heart murmurs with a Class I indication. It all adds up to an exceptional listening experience compared to acoustic scopes.

Black - 3200BK27
Burgundy - 3200BU
Navy - 3200NB



MASTER CARDIOLOGY



Smoke Finish

The Master Cardiology provides the best acoustics Littmann stethoscopes offer. Solid stainless steel single sided chestpiece. Two tubes in one design reduces noise from two tubes rubbing together. Soft sealing eartips. Patented Littmann® special procedure adapter allows auscultation of difficult body parts, and pediatric or emaciated patients.

Black (22") - 2159	Plum - 2167
Black (27") - 2160	Burgundy - 2163
Hunter - 2165	All Black - 2161
Navy - 2164	Caribbean - 2178
Brass Finish/Black Tube - 2175	
Smoke Finish/Black Tube - 2176	

CARDIOLOGY S.T.C.



Plum

Innovative design and outstanding acoustics are combined with a unique and easy to grasp Soft-Touch Chestpiece that allows easy movement between auscultation sites. Single sided stainless steel chestpiece provides both bell and diaphragm frequency responses. Diaphragm allows user to alternate between low and high frequency by applying pressure.

Black (27") - 4471
Burgundy - 4472
Navy - 4473
Plum - 4475

CARDIOLOGY III

The Cardiology III has superior versatility and outstanding acoustics with two patented tunable diaphragms on a stainless steel two-sided chestpiece that allows the alternating between low and high-frequency sounds. Two-tubes-in-one design.

Copper Finish



Black (22") - 3127	Gray - 3136
Black (27") - 3128	Chocolate - 3137
Burgundy - 3129	Caribbean - 3138
Ceil Blue - 3146	Coral Pink - 3149
Hunter - 3134	Red - 3140
Navy - 3130	All Black - 3131BE
Plum - 3135	Raspberry - 3148
Dark Olive - 3166	Sand - 3165
Brass Finish/Black Tube - 3128BRS	
Copper Finish/Chocolate Tube - 3137CPR	
Rainbow Finish/Black Tube - 3152RBW	

SELECT

A convenient tunable diaphragm in a single-sided, coated alloy chest-piece providing reliable and clear acoustics. The Select Stethoscope features a tunable diaphragm that allows the user to conveniently alternate between bell and diaphragm modes by applying simple pressure on the chestpiece. Its clear acoustics offer an advantage to healthcare professionals when listening to heart, lung and blood pressure sounds.

Ocean Blue



Black - 2290	Royal - 2298
Burgundy - 2293	Purple - 2294
Caribbean - 2291	Pine Green - 2305
Ceil Blue - 2301	Ocean Blue - 2306
Lilac - 2303	Peach - 2310
Raspberry - 2296	Pearl Pink - 2292

MASTER CLASSIC II

Offers efficiency in stethoscope auscultation that is unprecedented in a general examination stethoscope. The bell and diaphragm modes are incorporated into a single-sided Master chestpiece. No need to remove the chestpiece from the patient and mechanically switch from bell to diaphragm sides.

Purple

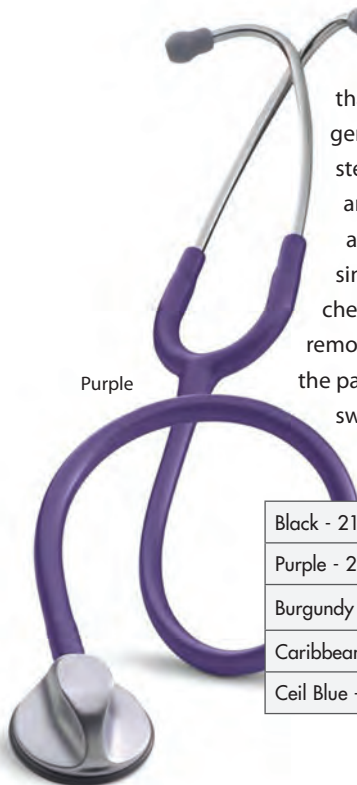

Black - 2144L	Hunter - 2632
Purple - 2143	Navy - 2147
Burgundy - 2146	Pine Green - 2634
Caribbean - 2630	All Black - 2141
Ceil Blue - 2633	Gold Edition - 2142G

VETERINARY MASTER CLASSIC II

This version of the Master Classic II features longer tubing for Veterinary professionals. Offers efficiency in stethoscope auscultation that is unprecedented in a general examination stethoscope. The bell and diaphragm modes are incorporated into a single-sided Master chestpiece.

Navy

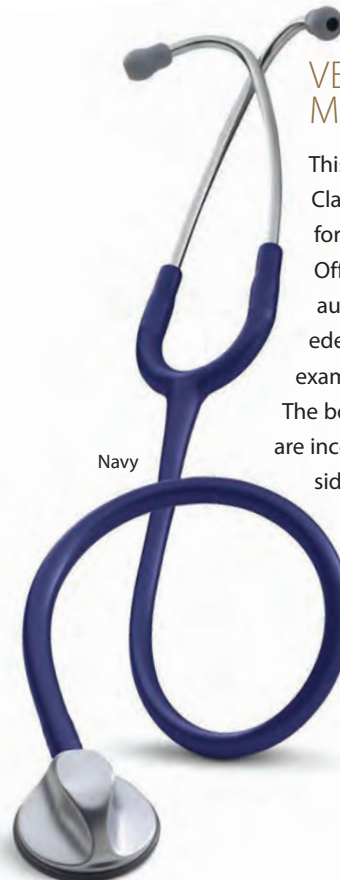

Navy - 1392

TRADITIONAL 2-SIDED

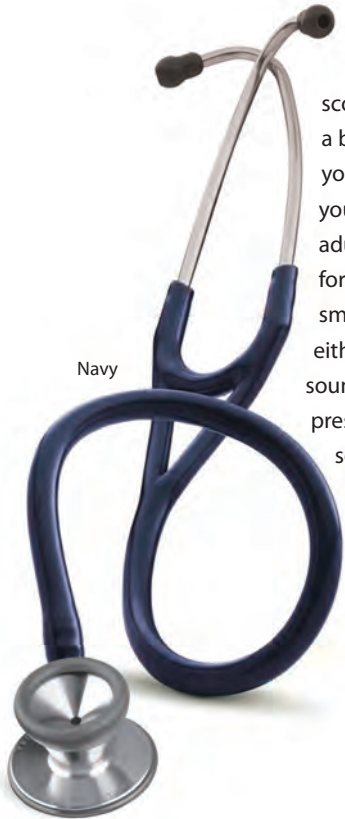

Navy

Offering you the best of the cardiology line of stethoscopes with the convenience of a built-in traditional bell allows you the option of easily being your best. One side sized for adults and the other side sized for pediatrics. Both the large and small side allows you to hear either low or high frequency sounds by simply applying varying pressure - light pressure for high sounds or firm pressure for low sounds utilizing 3M's own tunable technology. And, a traditional bell is built into both sides complete with a nonchill rubber sleeve.

Black - 3141
Burgundy - 3143
Navy - 3142

CLASSIC II SE



Brass Finish

A dual frequency, tunable diaphragm that allows you to listen to both low or high frequency. Firm pressure for high frequency sounds and light pressure to hear low frequency sounds.

Black - 2201	Purple - 2209
Burgundy - 2211	Orange - 2812
Caribbean - 2206	Raspberry - 2210
Ceil Blue - 2813	Royal - 2215
Gray - 2203	Pine Green - 2818
Hunter - 2208	Ocean Blue - 2819
Navy - 2205	Peach - 2822
Dark Olive - 2942	Sand - 2941
Pearl Pink - 2817	All Black - 2218BE
Brass Finish/Black Tube - 2201BRS	
Copper Finish/Chocolate Tube - 2820CPR	
Rainbow Finish/Caribbean Tube - 2823	
Rainbow Finish/Raspberry Tube - 2829RBW	
Smoke Finish/Black Tube - 2827SM	

CLASSIC II SE PEDIATRIC

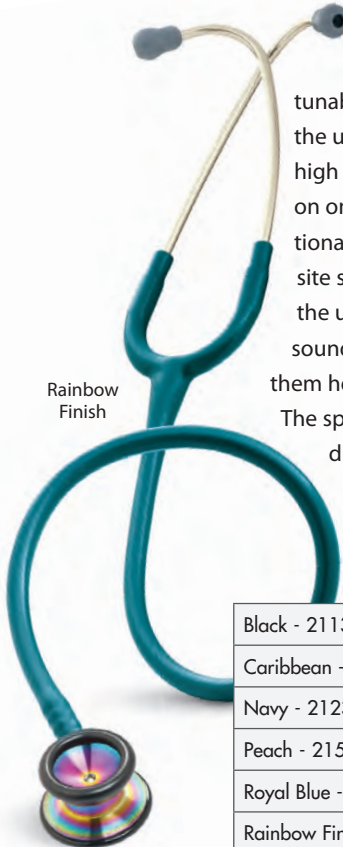

Rainbow Finish

The Classic II SE Pediatric features a dual frequency, tunable diaphragm that allows the user to listen to both low and high frequency. The diaphragm on one side augments the traditional bell function for the opposite side. Firm pressure allows the user to hear high frequency sounds and light pressure lets them hear low frequency sounds.

The specially designed bell and diaphragm chestpiece that is designed, sized and acoustically precise for children.

Black - 2113	Raspberry - 2122
Caribbean - 2119	Red - 2113R
Navy - 2123	Pine Green - 2131
Peach - 2154	Orange - 2155
Royal Blue - 2136	Pearl Pink - 2115
Rainbow Finish/Caribbean Tube - 2153	

CLASSIC II SE INFANT

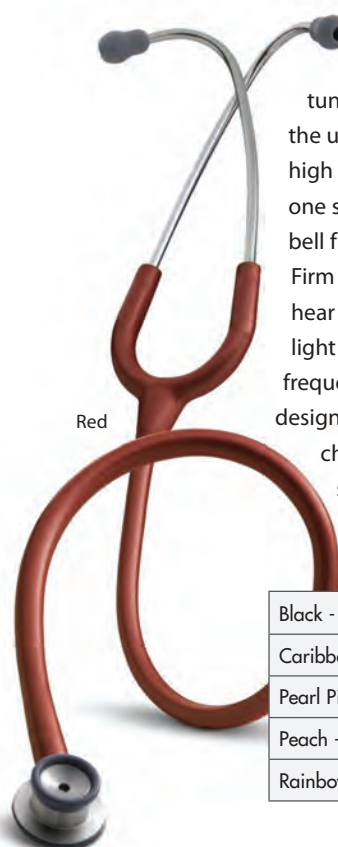

Red

The Classic II SE Infant features a dual frequency, tunable diaphragm that allows the user to listen to both low and high frequency. The diaphragm on one side augments the traditional bell function for the opposite side. Firm pressure allows the user to hear high frequency sounds and light pressure lets them hear low frequency sounds. The specially designed bell and diaphragm chestpiece that is designed, sized and acoustically precise for infants.

Black - 2114	Raspberry - 2125
Caribbean - 2124	Red - 2114R
Pearl Pink - 2120	Royal Blue - 2156
Peach - 2158	Orange - 2179
Rainbow Finish/Raspberry Tube - 2157	

LIGHTWEIGHT II SE

The perfect entry level and affordable choice stethoscope. The tunable diaphragm assures acoustic sensitivity and alternates between high and low frequency sounds. Special lightweight construction.

Ceil Blue



Black - 2450
Burgundy - 2451
Caribbean - 2452
Lilac - 2453
Ceil Blue - 2454
Pearl Pink - 2456
Seafoam - 2455

MASTER CLASSIC II TEACHING

The 3M Littmann® Master Classic II Stethoscope has two headsets, which allow instructor and student to perform simultaneous auscultation. The Master Classic II stethoscope features one black and one burgundy tube and has a single-sided chestpiece with the tunable diaphragm.

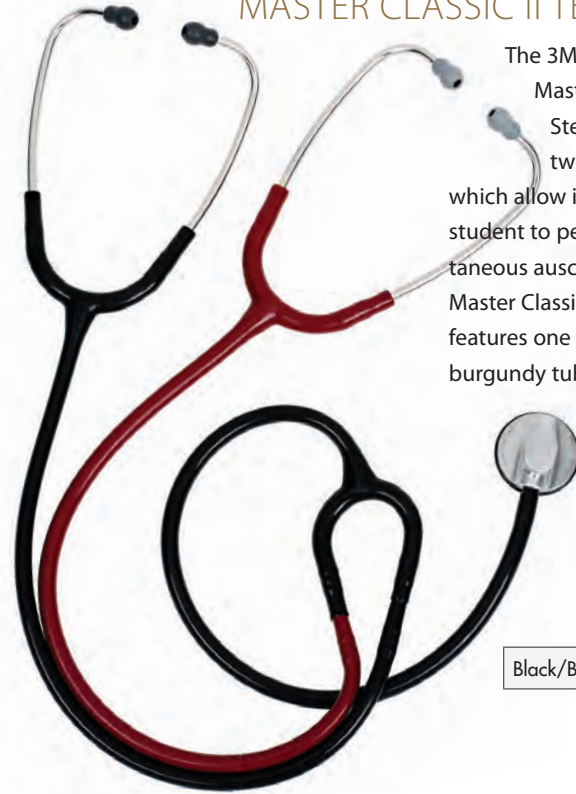

Black/Burgundy - 2139

CLASSIC II SE TEACHING

The 3M Littmann® Classic II S.E. Stethoscope has two headsets, which allow instructor and student to perform simultaneous auscultation. The Master Classic II stethoscope features one black and one burgundy tube and has a single-sided chestpiece with the tunable diaphragm.

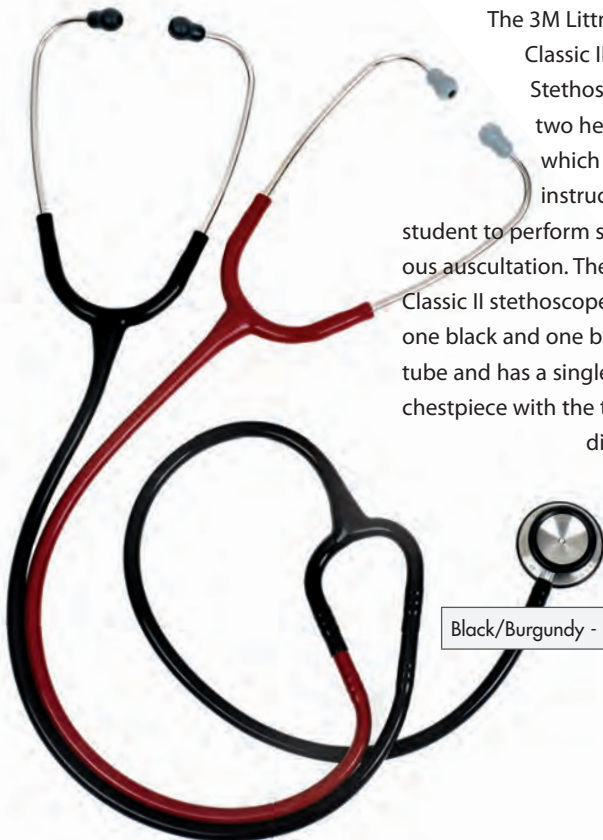

Black/Burgundy - 2138

LITTMANN® LEARNING SOFTWARE



Learn how to identify the different sounds of both the heart and lungs. Comes on a compact disk.

Learning Lung Sounds - 5110

Introduction to Heart Sounds - 5111

LITTMANN® PARTS & MATERIALS



Please see page 7 of our 2013 Price List for a complete list of Littmann® replacement parts and materials.



ANEROID SPHYGMOMANOMETERS & COMBINATION KITS

What makes Prestige Medical a leader in aneroid sphygmomanometers and combination kits?

■ Lifetime Warranty

Accuracy and performance are what Prestige Medical's aneroid sphygmomanometers are renowned for. Each manometer gauge is individually tested to meet or exceed the stringent guidelines set by the American National Standards Institute.

It is because of this rigorous testing that most Prestige Medical aneroid sphygmomanometer models are backed with a Lifetime Calibration Warranty.

■ More Choices

Offering the largest selection of solid colors and fashion prints in the industry, Prestige Medical is truly committed in personalizing the instruments of healthcare.

New prints and styles are added based on feedback from our dealers and consumers. Visit us online at www.prestigemedical.com to view all of our styles in each of their unique color offerings by simply clicking on the associated color swatches.

■ Custom Combination Kits

Perfect for group orders.

If you don't see a combination kit here that meets your needs, simply create your own. Prestige Medical offers hundreds of possible combinations.

To create your own custom combination kit, please contact customer service or your sales representative.

Anatomy of an Aneroid Sphygmomanometer

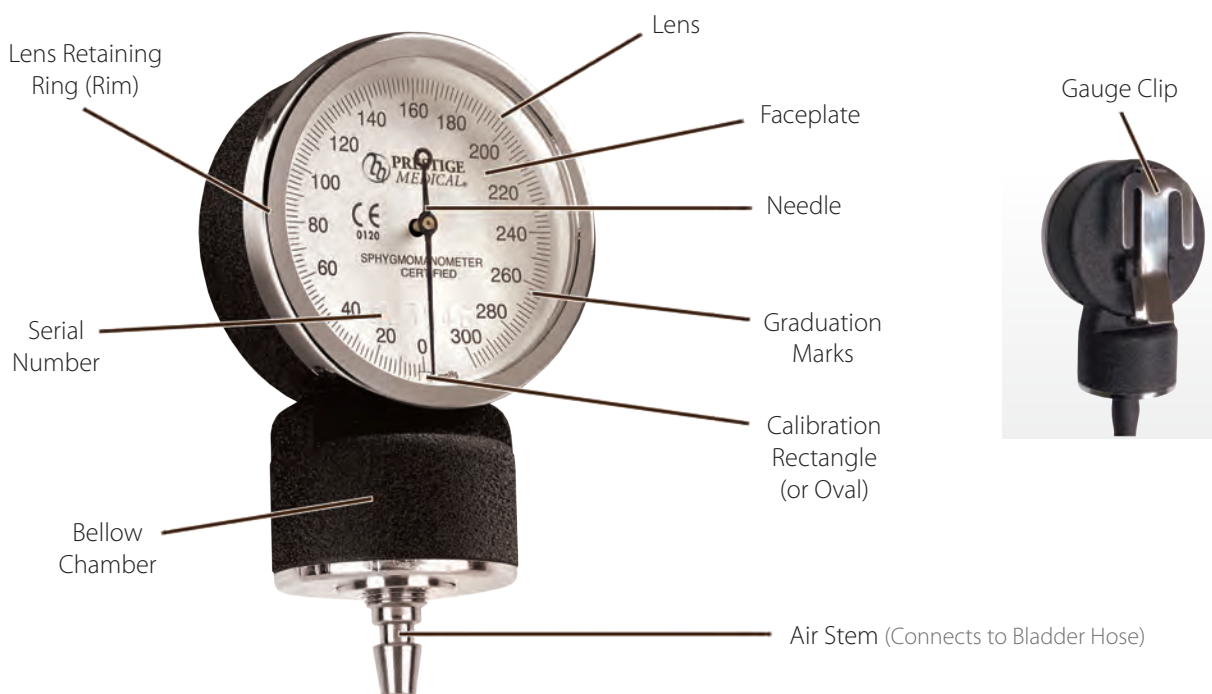



Personalizing
the instruments
of healthcare

Premium Aneroid Sphygmomanometer

Models : **82 (Box)**, **S82 (Clamshell)**

- Our most popular adult size aneroid sphygmomanometer
- Lifetime Calibration Warranty

Features: Latex free, nylon cuff, Index and Range markings, artery indicator mark, gauge holder, owner ID label, standard inflation bulb and air release valve

Cuff Range: 10" - 16"*

*Range refers to the arm circumference that the cuff is designed to operate on



Cuff Colors:



Cuff Prints:



Premium Large Adult Aneroid Sphygmomanometer

Model : **82-OB (Box)**

- Premium aneroid sphygmomanometer correctly sized for use on large adults
- Lifetime Calibration Warranty

Features: Latex free, nylon cuff, Index and Range markings, artery indicator mark, ID label, gauge holder, standard inflation bulb and air release valve

Cuff Range: 13.5" - 20"*

*Range refers to the arm circumference that the cuff is designed to operate on



Cuff Colors:



*A portion of the sale of all pink ribbon items is donated to the American Cancer Society.

Premium Pediatric & Infant Aneroid Sphygmomanometers

- Premium aneroid sphygmomanometer correctly sized for use on infants, children, or small adults
- Lifetime Calibration Warranty

Features: Latex free, nylon cuff, Index and Range markings, artery indicator mark, ID label, gauge holder, standard inflation bulb and air release valve

Cuff Range: Pediatric : 7.25"–10.5"* , Infant : 5"–7.25"*

*Range refers to the arm circumference that the cuff is designed to operate on

82-PED Pediatric Cuff (Box)
82-INF Infant Cuff (Box)

Cuff Color:



BLK
Black

Cuff Prints:

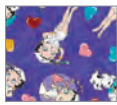

BCH
Betty Boop
Colored Hearts



Standard Aneroid Sphygmomanometer

Models : **79** (Box), **S79** (Clamshell)

- Standard adult size aneroid sphygmomanometer
- 10 Year Calibration Warranty

Features: Latex free, nylon cuff, Index and Range markings, artery indicator mark, gauge holder, owner ID label, standard inflation bulb and air release valve

Cuff Range: 10"–16"*

*Range refers to the arm circumference that the cuff is designed to operate on

Cuff Colors:



BLK Black BUR Burgundy CBL Ciel NAV Navy PUR Purple ROY Royal

Cuff Prints:



BAL Balloons CGS Chocolate Golden Swirls DCS Designer Colored Symbols PAI Paisley



Premium Aneroid Sphygmomanometer with Carry Case

Model : **882** (Clear Box)

- Our most popular aneroid sphygmomanometer (82/S82) color-matched with an extra-large 6" x 9" nylon carry case
- Lifetime Calibration Warranty

Features: Latex free, nylon cuff, Index and Range markings, artery indicator mark, gauge holder, owner ID label, standard inflation bulb and air release valve

Cuff Range: 10" - 16"*

*Range refers to the arm circumference that the cuff is designed to operate on



Ribbons and Hearts Pink

Cuff and Case Colors:



Cuff and Case Prints:



Premium X-Large Adult Aneroid Sphygmomanometer

Model : **882-TH-BLK** (Clear Box)

- Premium aneroid sphygmomanometer correctly sized for use on extra-large adults or a thigh
- Lifetime Calibration Warranty

Features: Latex free, nylon cuff, Index and Range markings, artery indicator mark, gauge holder, owner ID label, standard inflation bulb and air release valve, extra-large 6" x 9" nylon carry case

Cuff Range: 16" - 26"*

*Range refers to the arm circumference that the cuff is designed to operate on



*A portion of the sale of all pink ribbon items is donated to the American Cancer Society.

3-in-1 Aneroid Sphygmomanometer Set with Carry Case

Model : **882-COM-BLK** (Clear Box)

- Features three interchangeable cuff sizes - pediatric, adult, and large adult
- Includes an extra-large 6" x 9" color-matched nylon carry case
- Lifetime Calibration Warranty

Features: Latex free, nylon cuff, Index and Range markings, artery indicator mark, gauge holder, owner ID label, standard inflation bulb and air release valve

Cuff Ranges: Adult : 10"-16"*
Pediatric : 7.25" - 10.5"*
Large Adult : 13.5" - 20"*

*Range refers to the arm circumference that the cuff is designed to operate on



Easy-ID™ Latex Free Aneroid Sphygmomanometer

- Unique terra-cotta color of the neoprene inflation system enables easy identification of its latex free properties
- Lifetime Calibration Warranty

Features: Latex free, nylon cuff, Index and Range markings, artery indicator mark, gauge holder, owner ID label, standard inflation bulb and air release valve

Cuff Range: Adult : 10"-16"*
Pediatric : 7.25" - 10.5"*
Large Adult : 13.5" - 20"*

*Range refers to the arm circumference that the cuff is designed to operate on

S72 -BLK	Adult (Clamshell)
S72-PED-BLK	Pediatric (Clamshell)
S72-OB-BLK	Large Adult (Clamshell)



Cotton Cuff Aneroid Sphygmomanometer

- The soft comfort of a cotton cuff is what sets this model apart
- Lifetime Calibration Warranty

Features: Latex free, cotton cuff, Index and Range markings, artery indicator mark, gauge holder, owner ID label, deluxe inflation bulb and air release valve

Cuff Range: Adult : 10"-16"*
Pediatric : 7.25" - 10.5"*
Large Adult : 13.5" - 20"*

*Range refers to the arm circumference that the cuff is designed to operate on

80	Adult (Box)
80-PED	Pediatric (Box)
80-OB	Large Adult (Box)



Single-Hand Dual Tube Aneroid Sphygmomanometer

Model : **883** (Clear Box)

- High performance integrated inflation bulb and manometer gauge for single hand operation
- Dual tube manometer gauge design enables it to be interchangeable with most dual tube cuffs
- Includes an extra-large 6" x 9" color-matched nylon carry case
- Lifetime Calibration Warranty

Features: Latex free, nylon cuff, Index and Range markings, artery indicator mark, gauge holder, owner ID label

Cuff Range: 10" - 16"*

**Range refers to the arm circumference that the cuff is designed to operate on*



Cuff and Case Colors:



BLK
Black

NAV
Navy

Single-Hand One Tube Aneroid Sphygmomanometer

Model : **887** (Clear Box)

- High performance integrated inflation bulb and manometer gauge for single hand operation
- Interchangeable only with other one tube cuffs
- Includes an extra-large 6" x 9" color-matched nylon carry case
- Lifetime Calibration Warranty

Features: Latex free, nylon cuff, Index and Range markings, artery indicator mark, gauge holder, owner ID label

Cuff Range: 10" - 16"*

**Range refers to the arm circumference that the cuff is designed to operate on*



Cuff and Case Colors:



BLK
Black

NAV
Navy



Clinical I® Combination Kit

Model : A126 (Clear Box)

- Our most popular aneroid sphygmomanometer matched with a Clinical I® stethoscope
- Includes an extra-large 6" x 9" color-matched nylon carry case
- Lifetime Calibration Warranty

Features: Latex free, nylon cuff, Index and Range markings, artery indicator mark, gauge holder, owner ID label, standard inflation bulb and air release valve, two sizes of soft eartips, extra diaphragm, stethoscope ID tag

Cuff Range: 10"-16"*

*Range refers to the arm circumference that the cuff is designed to operate on



Ribbons and Hearts Purple

Cuff / Stethoscope Colors:



Black Cuff / Neon Stethoscope:



Cuff Prints / Stethoscope Colors:





Clinical Lite™ Combination Kit

Model : A121 (Clear Box)

- Our most popular aneroid sphygmomanometer matched with a Clinical Lite™ stethoscope
- Includes an extra-large 6" x 9" color-matched nylon carry case
- Lifetime Calibration Warranty

Features: Latex free, nylon cuff, Index and Range markings, artery indicator mark, gauge holder, owner ID label, standard inflation bulb and air release valve, two sizes of soft eartips, extra diaphragm, stethoscope ID tag

Cuff Range: 10"-16"*

*Range refers to the arm circumference that the cuff is designed to operate on



Neon Green

Cuff / Stethoscope Colors:



Black Cuff / Neon Stethoscope:



Cuff Prints / Stethoscope Colors:

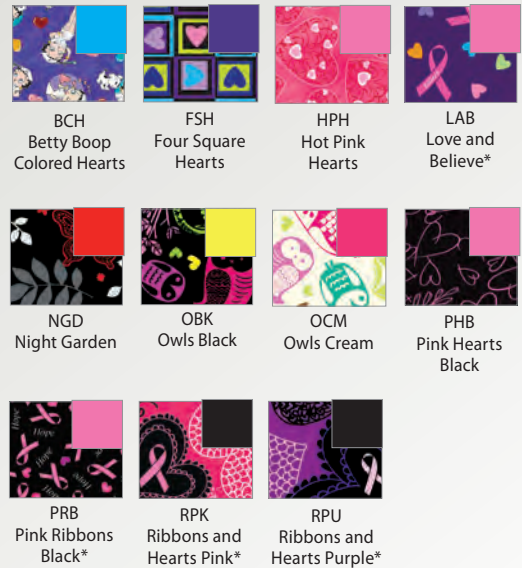

*A portion of the sale of all pink ribbon items is donated to the American Cancer Society.



Clinical I Nurse Kit®

Model : **SK126** (Clamshell)

- Perfectly suited for use by medical students and healthcare professionals
- Lifetime Warranty with Free Lifetime Replacement Parts on stethoscope

Includes: Clinical I® stethoscope, nylon pocket organizer, Medimeter™, 5½" Lister bandage scissor, 4-color chart pen, disposable penlight

Tube Colors - Solid:



BLK Black HPK Hot Pink HUN Hunter NAV Navy PAC Pacific



PUR Purple RED Red ROY Royal STE Stealth

Tube Colors - Neon:

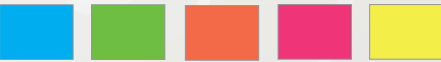

N-BLU Neon Blue N-GRN Neon Green N-ORG Neon Orange N-PNK Neon Pink N-YEL Neon Yellow



Purple



Clinical Lite Nurse Kit®

Model : **SK121** (Clamshell)

- Perfectly suited for use by medical students and healthcare professionals
- Lifetime Warranty with Free Lifetime Replacement Parts on stethoscope

Includes: Clinical Lite™ stethoscope, nylon pocket organizer, Medimeter™, 5½" Lister bandage scissor, 4-color chart pen, disposable penlight

Tube Colors - Solid:



BLK Black HPK Hot Pink HUN Hunter NAV Navy PUR Purple



RED Red ROY Royal STE Stealth

Tube Colors - Neon:



N-BLU Neon Blue N-GRN Neon Green N-ORG Neon Orange N-PNK Neon Pink N-YEL Neon Yellow



Neon Orange

Aneroid Sphygmomanometer / Sprague-Rappaport Kit

Model : **A2** (Clear Box)

- Our most popular aneroid sphygmomanometer matched with the best-selling Sprague-Rappaport
- Includes an extra-large 6" x 9" color-matched nylon carry case
- Lifetime Calibration Warranty

Features: Latex free, nylon cuff, Index and Range markings, artery indicator mark, gauge holder, owner ID label, standard inflation bulb and air release valve, full accessory pouch for Sprague-Rappaport

Cuff Range: 10"–16"*

*Range refers to the arm circumference that the cuff is designed to operate on



Cuff / Stethoscope Colors:



Black Cuff / Neon Stethoscope:



Cuff Prints / Stethoscope Colors:

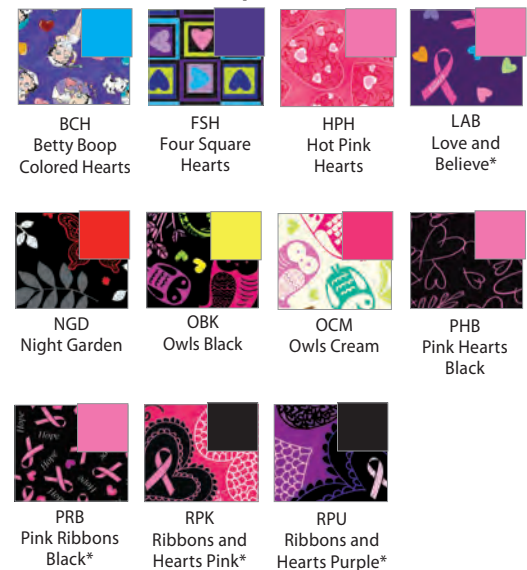

*A portion of the sale of all pink ribbon items is donated to the American Cancer Society.

Aneroid Sphygmomanometer / Sprague-Rappaport Nurse Kit®

Model : **A5** (Clear Box)

- Same features as our best-selling A2 kit, but includes a nylon pocket organizer, disposable penlight, Medimeter™, 5½" Lister bandage scissor and 4-color chart pen
- Includes an extra-large 6" x 9" color-matched nylon carry case
- Lifetime Calibration Warranty

Features: Latex free, nylon cuff, Index and Range markings, artery indicator mark, gauge holder, owner ID label, standard inflation bulb and air release valve, full accessory pouch for Sprague-Rappaport
Cuff Range: 10"-16"*

* Range refers to the arm circumference that the cuff is designed to operate on



Night Garden

Cuff / Stethoscope Colors:



Black Cuff / Neon Stethoscope:



Cuff Prints / Stethoscope Colors:

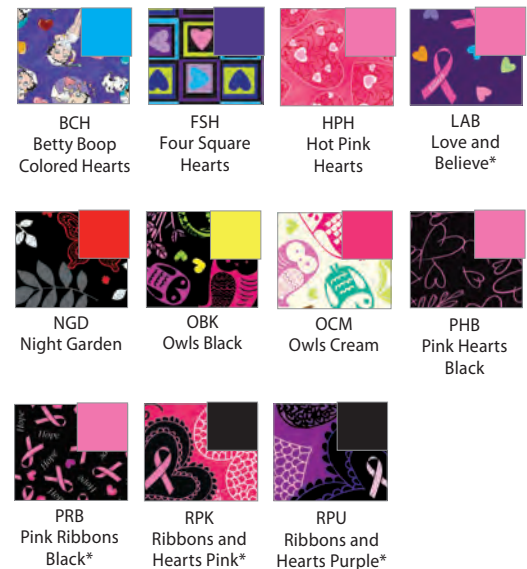

Sprague-Rappaport Nurse Kit®

Model : **SK122** (Clamshell)

- Perfectly suited for use by medical students and healthcare professionals
- Lifetime Warranty with Free Lifetime Replacement Parts on stethoscope

Includes: Sprague-Rappaport stethoscope, nylon pocket organizer, Medimeter™, 5½" Lister bandage scissor, 4-color chart pen, disposable penlight

Tube Colors - Solid:



Tube Colors - Neon:



Tube Colors - Frosted:



Group Orders



Custom Combination Kits

If you don't see a combination kit here that meets your needs, simply create your own. Prestige Medical offers hundreds of possible combinations.

To create your own custom combination kit, please contact customer service or your sales representative.

Basic Single Head Stethoscope

Model : **103-BLK** (Box)

- Economical single head stethoscope
- Black only

Overall Length: Appx. 31.5"*
Weight: Appx. 2.8 oz*
Warranty: One Year

** Due to the handmade craftsmanship and material attributes, actual specifications may vary*



Basic Dual Head Stethoscope

Model : **104-BLK** (Box)

- Economical dual head stethoscope
- Black only

Accessories Included: Soft PVC eartips
Overall Length: Appx. 32"*
Weight: Appx. 3.8 oz*
Warranty: One Year

** Due to the handmade craftsmanship and material attributes, actual specifications may vary*



Basic Sprague-Rappaport Stethoscope

Model : **105-BLK** (Box)

- Economical Sprague-Rappaport stethoscope
- Black only

Accessories Included: Soft PVC eartips, adult and pediatric diaphragms, pediatric diaphragm assembly, pediatric and infant bells
Overall Length: Appx. 30"*
Weight: Appx. 7.2 oz*
Warranty: One Year

** Due to the handmade craftsmanship and material attributes, actual specifications may vary*



Basic SpragueLite® Stethoscope

Model : **110-BLK** (Box)

- Economical SpragueLite® stethoscope
- Black only

Accessories Included: Soft PVC eartips, adult and pediatric diaphragms, pediatric diaphragm assembly, pediatric and infant bells
Overall Length: Appx. 32"*
Weight: Appx. 4.9 oz*
Warranty: One Year

** Due to the handmade craftsmanship and material attributes, actual specifications may vary*



Basic Classic Stethoscope

Model : **117-BLK** (Box)

- Economical Classic stethoscope
- Black only

Accessories Included: Two sizes of soft silicone eartips, replacement diaphragm
Overall Length: Appx. 27"
Weight: Appx. 7.0 oz*
Warranty: One Year

* Due to the handmade craftsmanship and material attributes, actual specifications may vary



Basic Aneroid Sphygmomanometer

- Economical aneroid sphygmomanometer
- Available in both adult and large adult sizes

Features: Latex free, nylon cuff, Index and Range markings, artery indicator mark, gauge holder, owner ID label, standard inflation bulb and air release valve
Cuff Range: Adult : 10"–16"* , Large Adult : 13.5" - 20"*
Warranty: One Year

*Range refers to the arm circumference that the cuff is designed to operate on

70 Adult
70-OB Large Adult (Black only)



Chocolate Golden Swirls

Cuff Color:



Cuff Prints: (Available for Model 70 Only)

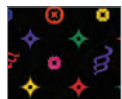

Basic Aneroid Sphygmomanometer Single Head Kit

Model : **A1-103** (Box)

- Economical aneroid sphygmomanometer / single head combination kit
- Black only

Features: Latex free, nylon cuff, Index and Range markings, artery indicator mark, gauge holder, owner ID label, standard inflation bulb and air release valve, extra-large 6" x 9" color-matched nylon carry case
Cuff Range: 10"–16"*
Warranty: One Year

* Range refers to the arm circumference that the cuff is designed to operate on



Basic Aneroid Sphygmomanometer Dual Head Kit

Model : **A1-104** (Box)

- Economical aneroid sphygmomanometer / dual head combination kit
- Black only

Features: Latex free, nylon cuff, Index and Range markings, artery indicator mark, gauge holder, owner ID label, standard inflation bulb and air release valve, extra-large 6" x 9" color-matched nylon carry case

Cuff Range: 10"-16"*

Warranty: One Year

* Range refers to the arm circumference that the cuff is designed to operate on



Basic Aneroid Sphygmomanometer Sprague-Rappaport Kit

Model : **A1-105** (Box)

- Economical aneroid sphygmomanometer / Sprague-Rappaport combination kit

Features: Latex free, nylon cuff, Index and Range markings, artery indicator mark, gauge holder, owner ID label, standard inflation bulb and air release valve, extra-large 6" x 9" color-matched nylon carry case, full accessory pouch for Sprague-Rappaport

Cuff Range: 10"-16"*

Warranty: One Year

* Range refers to the arm circumference that the cuff is designed to operate on



Cuff / Sprague Color:



BLK
Black

Cuff Prints / Black Sprague:

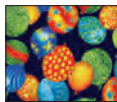

BAL
Balloons

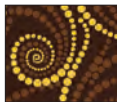

CGS
Chocolate
Golden Swirls

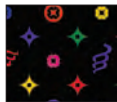

DCS
Designer
Colored Symbols



PAI
Paisley

Basic Aneroid Sphygmomanometer SpragueLite® Kit

Model : **A1-110** (Box)

- Economical aneroid sphygmomanometer / SpragueLite® combination kit
- Black only

Features: Latex free, nylon cuff, Index and Range markings, artery indicator mark, gauge holder, owner ID label, standard inflation bulb and air release valve, extra-large 6" x 9" color-matched nylon carry case, full accessory pouch for SpragueLite®

Cuff Range: 10"-16"*

Warranty: One Year

* Range refers to the arm circumference that the cuff is designed to operate on





Veterinary Clinical I®

Model : **V126** (Box)

- A classic dual head stethoscope enhanced with all stainless steel construction
- Features 2" longer tubing to enable easier auscultation of larger animals
- Lifetime Warranty with Free Lifetime Replacement Parts



Navy

eartips Soft Silicone

tubing Thick Walled PVC

metal Stainless Steel

Accessories Included: Two sizes of soft eartips, replacement diaphragm

Overall Length: Appx. 33"*

Weight: Appx. 5.9 oz*

Ideal For: Veterinarians

*Due to the handmade craftsmanship and material attributes, actual specifications may vary

Tube Colors - Solid:



BLK
Black



NAV
Navy



PUR
Purple

Veterinary Otoscope

Model : **V3420-L** (Slide Pack)

- Features a long specula
- Twist activated
- Dual-focused standard illumination
- Includes five sizes of reusable specula (cold autoclavable)
- Otoscope head can be removed to convert into penlight
- Includes two AAA batteries

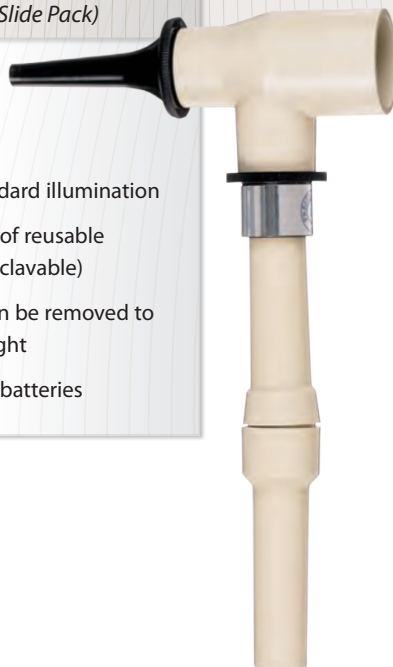

Veterinary Cloisonné Emblem Pins

Each emblem pin is handmade using old world craftsmanship. Painstaking attention to detail and fine gold plating enhance each pin and provide a distinguished appearance. One pin per package.



1049
Veterinary
Medicine



1050
Veterinary
Technician



1051
Registered
Veterinary
Technician

Premium Fingertip Pulse Oximeter

Model : 450* (Box)

- Fingertip measurement of SpO2% (Oxygen Saturation) and pulse rate
- OLED multi-color graphics display screen with six display modes
- Low power consumption (up to 30 hours of continuous use) with auto shut-off



White

Includes: Soft silicone protective case and lanyard, Two AAA batteries
Warranty: One Year

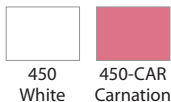

Fingertip Pulse Oximeter

Model : 455* (Box)

- Fingertip measurement of SpO2% (Oxygen Saturation) and pulse rate
- Red LED display screen
- Low power consumption with auto shut-off feature
- Up to 30 hours of continuous use



Grey

Includes: Soft silicone protective case and lanyard, Two AAA batteries
Warranty: One Year



Basic Fingertip Pulse Oximeter

Model : 456* (Box)

- Fingertip measurement of SpO2% (Oxygen Saturation) and pulse rate
- Red LED display screen
- Low power consumption (up to 30 hours of continuous use) with auto shut-off



Purple

Includes: Soft silicone protective case Nylon lanyard Two AAA batteries
Warranty: One Year



StepMate™ Pedometer

Model : 440-PRW* (Box)

- Counts distance, steps, and calories simultaneously
- Easily clips to any waistband or belt
- Convenient fold out display reads face-up to the user
- 12 / 24 hour clock
- A portion of the sale of this product is donated to the American Cancer Society



Includes: LR44 button cell battery



WristMate™ Digital Blood Pressure Monitor

Model : **HM-50*** (Box)

- Automatic blood pressure and pulse rate monitor that measures from the wrist
- One-touch operation and clinically tested for accuracy
- Recalls up to 40 prior readings for up to three users
- Includes World Health Organization (WHO) indicator for blood pressure classification

Includes : Two AAA batteries and plastic storage case

Cuff Range: 5.3" - 7.5"*

Warranty: Two Year

**Range refers to the wrist circumference that the cuff is designed to operate on*



HealthMate® Digital Blood Pressure Monitor

Model : **HM-30*** (Box)

- Fully automatic blood pressure and pulse rate monitor
- One-touch operation and clinically tested for accuracy
- Recalls up to 99 prior readings
- World Health Organization (WHO) indicator for BP classification

Includes : Four AA batteries, DC power port and nylon storage case

Cuff Range: Adult: 9" - 13"* , Large Adult: 13" - 17"*

Warranty: Two Year

**Range refers to the arm circumference that the cuff is designed to operate on*

HM-30 Adult Cuff

HM-30-OB Large Adult Cuff



Traditional Home Blood Pressure Set

Model : **81** (Box)

- D-Ring in cuff enables easy self-fastening
- Black cotton cuff with owner ID and artery indicator label

Includes : Cotton cuff with attached single head stethoscope

Cuff Range: Adult : 10" - 16"* , Large Adult : 13.5" - 20"*

Warranty: Lifetime Calibration

**Range refers to the arm circumference that the cuff is designed to operate on*

81 Adult Cuff

81-OB Large Adult Cuff



Flexible Tip Digital Thermometer

Model : **DT-3*** (Box)

- Flexible tip for added safety
- Measures in Fahrenheit or Celsius
- 10 second reading
- Recalls last reading

Includes: Five probe covers, LR41 button battery

Warranty: One Year



Standard Digital Thermometer

Model : **DT*** (Box)

- For use orally, rectally, or under the arm
- Measures in both Fahrenheit or Celsius
- 60 second reading
- Recalls last reading

Includes: Five probe covers, LR41 button battery

Warranty: One Year



DT
White

HPK
Hot
Pink

N-PNK
Neon
Pink

N-YEL
Neon
Yellow

N-GRN
Neon
Green

Cool Colors™ Digital Thermometer

Model : **DT-6*** (Clear Case)

- Same features of the standard DT but in five translucent case colors
- For use orally, rectally, or under the arm
- Measures in both Fahrenheit or Celsius
- 60 second reading
- Recalls last reading

Includes: Five probe covers, LR41 button battery

Warranty: One Year



KIW
Kiwi

LIL
Lilac

OCE
Ocean

RUB
Ruby

SEA
Seabreeze

Standard Probe Covers

Model : **DT-50** (Box)

Retail box of 50 probe covers. Fits DT, DT-3 and DT-6.



Digital Ear Thermometer

Model : **DT-23*** (Clamshell)

- Infrared measuring technology
- Instant one second reading from the ear
- Swivel probe tip for an adjustable fit
- Comfortable ergonomic handle
- Measures in Fahrenheit or Celsius
- Recalls last reading

Includes: 20 probe covers, Two AAA batteries
Warranty: One Year



Temporal / Ear Digital Thermometer

Model : **DT-28*** (Clamshell)

- Dual-Use Temporal and Ear Infrared Thermometer
- Instant one second readings
- 360° Rotating Tip for Optimal Placement
- Measures in Fahrenheit or Celsius
- Memory of Prior 10 Readings
- Fever Alarm

Includes: One CR2032 battery
Warranty: One Year



Ice / Hot Water Bottles

- Made of natural rubber latex
- For use with cold and hot liquids
- Clear box packaging

4220 2 qt. fountain syringe kit
4200 2 qt. Ice/Hot water bottle with stopper
4210 2 qt. Ice/Hot stopperless water bottle



4220



4200



4210

Rubber Invalid Rings

- Made of natural rubber latex
- Each invalid ring features a metal valve
- Clear box packaging

4214 14" diameter ring (35cm)
4216 16" diameter ring (40cm)
4218 18" diameter ring (45cm)



4214



4216



4218

Standard Disposable Penlight

- Clip activated with standard illumination
- Plastic construction
- Available in 15 colors

200 Poly Bag
S200 Slide Pack
200-AST Cylinder (22)



Neon Orange

Pupil Gauge Disposable Penlight

- Pupil gauge imprint
- Clip activated
- Plastic construction
- Standard illumination

210 Poly Bag
S210 Slide Pack
210-CYL Cylinder (22) White only
210-AST Cylinder (22) Asst. Colors



210 White with Royal Print

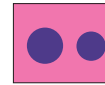

210-HPK Hot Pink with Purple Print



210-NAV Navy with White Print



Hot Pink

Pearlescent Disposable Penlight

- Clip activated
- Plastic construction with a "Pearlescent" finish
- Standard illumination

203 Poly Bag
S203 Slide Pack
203-AST Cylinder (22)

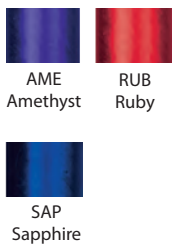

Sapphire

QuickLite™ Pupil Gauge Penlight

- Pupil gauge imprint
- Push button activated
- Metal construction
- Standard illumination
- Includes two AAA batteries

229 Poly Bag
S229 Slide Pack
229-CYL Cylinder (20)



QuickLite™ Penlight

- Push button activated
- Metal construction
- Standard illumination
- Includes two AAA batteries

222 Poly Bag
S222 Slide Pack
222-AST Cylinder (20)

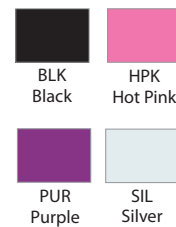

WHT White



Purple

German Diagnostic Penlight

- Made in Germany
- Push button activated
- All-metal construction
- Standard illumination
- Includes two AAA batteries

280 Poly Bag
S280 Slide Pack



PocketLite™ Penlight

- Clip activated
- Plastic construction
- Standard illumination
- Includes two AAA batteries

260 Poly Bag
S260 Slide Pack
260-AST Cylinder (20)

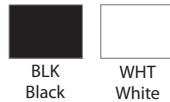

LED Penlight

- Push button activated
- Metal construction
- Bright LED illumination
- Includes one AAA battery

204 Poly Bag
S204 Slide Pack
204-AST Cylinder (20)

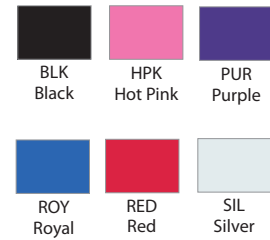

Red

Xenon Pocket Otoscope

Model : **3470** (Slide Pack)

- Twist activated
- 6000 candle power xenon lamp with 3X magnification
- Comes with one reusable specula (cold autoclavable)
- Includes two sizes of disposable specula and coverter by Welch Allyn®
- Otoscope head can be removed to convert into penlight/flashlight
- Includes two AAA batteries

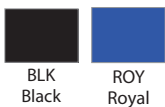

Standard Pocket Otoscope

Model : **3420** (Slide Pack)

- Twist activated
- Dual-focused standard illumination with 2.5X magnification
- Includes five sizes of reusable specula (cold autoclavable)
- Otoscope head can be removed to convert into penlight
- Includes two AAA batteries

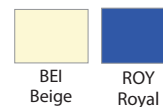

Taylor Percussion Hammer

Model : 25

- Intended to elicit patellar reflexes and myotatic reflexes
- Tapered handle tip is designed to elicit plantar reflexes
- 7½" chrome plated handle & PVC bumper

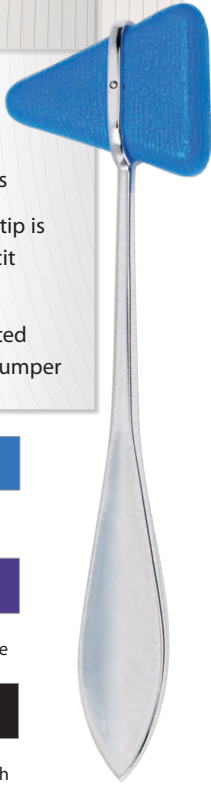

Economy Taylor Percussion Hammer

Model : 28

Same as model 25, but available in burnt orange only.



Ergonomic Diagnostic Hammer

Model : 22

- Combines features of the Taylor Percussion Hammer with a neurological hammer
- Retracting filament mounted at the base of the handle to elicit nervous system responses
- 6" anodized handle

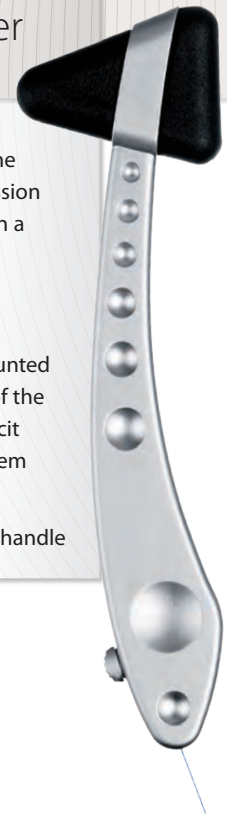

Buck Neurological Hammer

Model : 26

- Designed to elicit myotatic reflexes and neurological responses
- Dual PVC bumpers for reflex tests
- Removable neurological pin
- Removable neurological brush
- 6¾" chrome plated handle



Queen Square Hammers

- Perfectly suited for eliciting a full range of reflexes
- Tapered handle base to enable plantar reflex testing
- Nylon plastic handle available in two lengths
- PVC bumper ring

23	14 inches
23-S	11½ inches

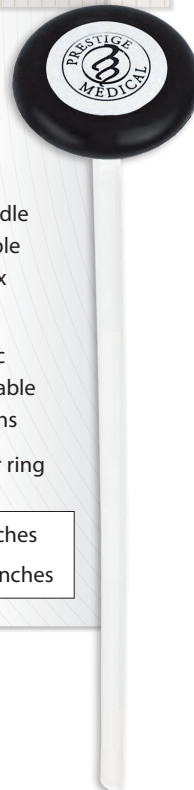

Babinski Telescoping Reflex Hammer

Model : 24

- Features a 14" telescoping handle
- Enables different percussion forces
- PVC bumper ring
- Convenient to carry in pocket
- Tapered handle base to enable plantar reflex testing



Trömner Reflex Hammer

Model : **27-BLK**

- 3-in-1 dual mallet reflex hammer
- Larger mallet elicits tendon stretch reflex, smaller mallet elicits myotatic reflexes
- HDP plastic handle designed for a comfortable grip
- Tapered handle tip enables plantar reflex testing
- Length: 9", Weight: 5.5 oz.

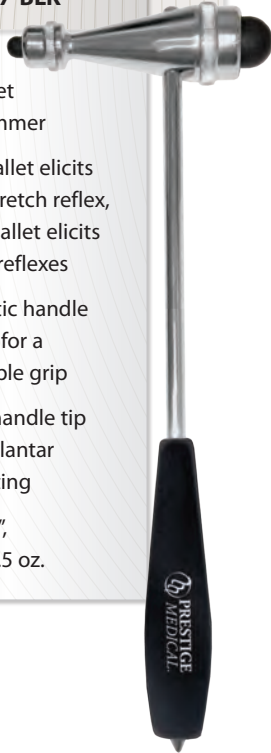

German EKG Caliper

Model : **46**

- Designed to measure electrocardiogram waveforms
- Plastic protective cover with molded ruler to aid with measurements
- Made in Germany



Economy EKG Caliper

Model : **36**

- Designed to measure electrocardiogram waveforms
- Plastic protective cover with molded ruler to aid with measurements

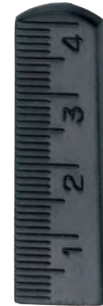

Tuning Forks

- C-1024 intended for higher-frequency hearing tests
- C-512 & C-256 intended for Rinne and Weber hearing tests
- C-128 intended for vibration and bone fracture tests
- C-128 & C-256 weighted to assure correct frequency
- Made of aluminum



C-1024



C-512



C-256

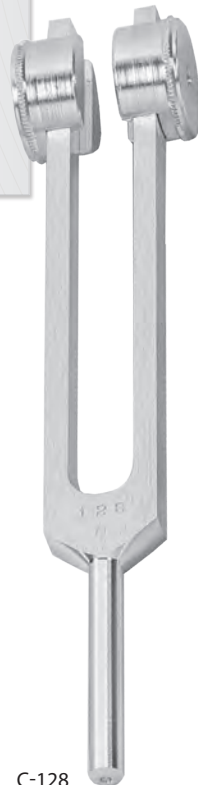

C-128

Nurse Assist™ Clipboard

- Features a clock, timer, alarm and calculator
- Constructed of heavy-duty ASB plastic
- Includes one L1131 battery
- Dimensions: 13.5" x 9"

3309 White

3309-PNK Pink



Goniometer

Model : 47

- Designed to measure the range of motion in joints
- Measures a 360° range in single degree increments
- Imprinted guide for gauging angles
- Measures in inches and centimeters
- Made from heavy-gauge clear plastic
- Conforms to ISOM measuring standards

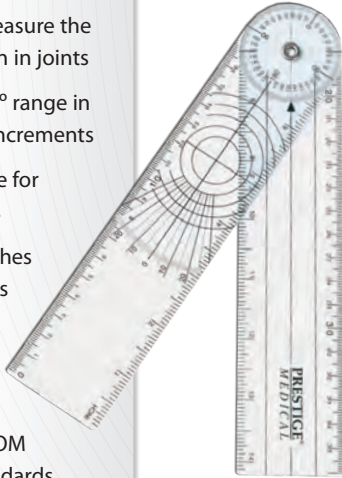

Protractor Goniometers

- Designed to measure the range of motion in joints
- Measures a 360° range in single degree increments
- Easy-read protractor
- Measures in inches and centimeters
- Made from heavy-gauge clear plastic
- Conforms to ISOM measuring standards

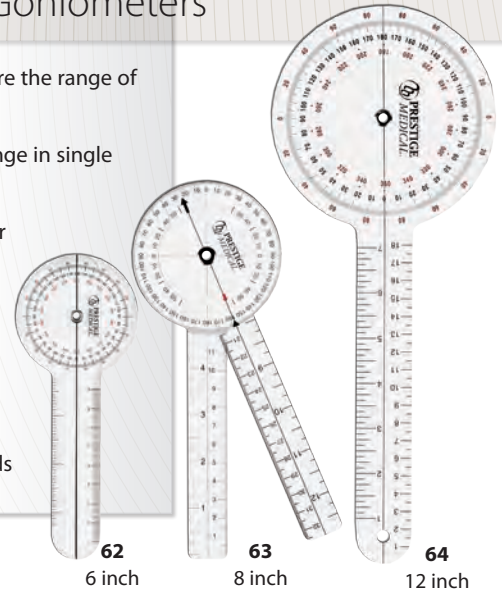

MediMeter™

Model : 49

- Pocket-size medical ruler in inches and centimeters
- Wound diameter / pupil dilation gauge
- Made from heavy-gauge clear plastic

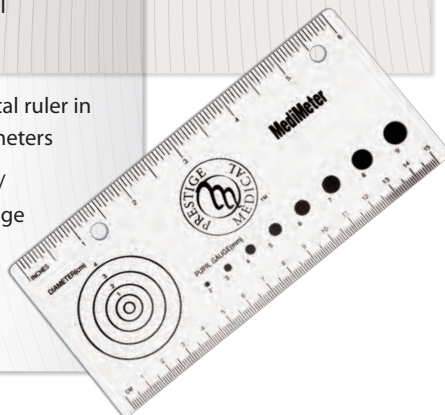

CardioMeter™

Model : 31

- Ruler for interpreting EKG waveforms
- Made from heavy-gauge clear plastic

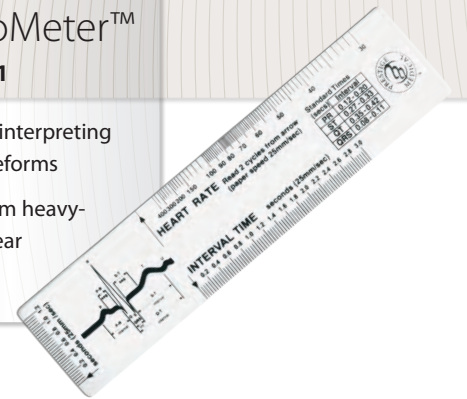

Snellen Pocket Eye Chart

Model : 3909

- Measures visual acuity at a distance
- Dim : 18.5cm x 10cm



Jaeger Eye Chart

Model : 32

- Measures near vision
- Dim : 17.5cm x 12cm

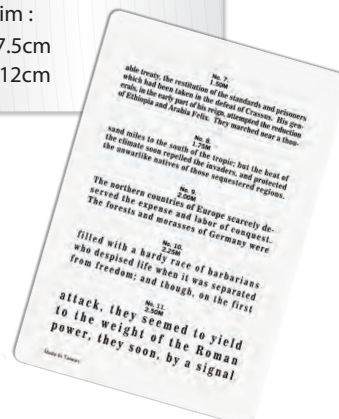

Pocket Eye Chart

Model : 3908

- Measures basic visual acuity
- Dim : 16cm x 9cm



Pain Assessment Card

Model : **3910**

- Uses Wong-Baker Faces for pain rating scale
- Includes PQRST and COLDERRA pain assessment descriptions
- Dimensions: 18cm x 7cm

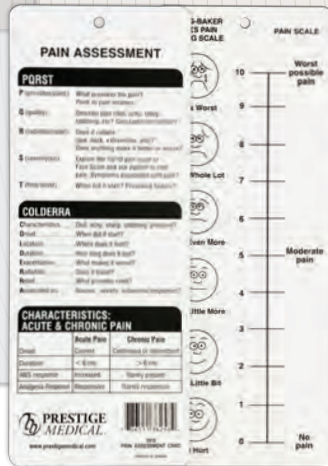

Disposable LifeMask® Face Shield

Model : **FS-24**

- Slim single use CPR face mask with 3M® Filtrete™ anti-viral filter
- Patented one-way valve with anti-viral filter
- Cylinder of 24 Face Shields



CPR LifeMask® in Plastic Bottle

Model : **M1**

- Single use CPR mask with 3M Filtrete™ anti-viral filter
- Patented one-way valve prevents cross-contamination
- Comes in a plastic waterproof bottle



CPR LifeMask® in Keychain Bag

Model : **M2**

- Single use CPR mask with 3M Filtrete™ anti-viral filter
- Patented one-way valve prevents cross-contamination
- Comes in a nylon zippered keychain bag

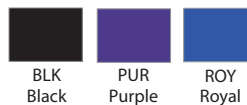

CPR Resuscitator

Model : **M10**

- Features a latex free air cushion that conforms to facial contours
- One-way valve with anti-viral filter to prevent cross-contamination
- Head strap
- Comes in hard shell storage case with lanyard



LifeMask® CPR Resuscitator

Model : **M20**

- Features a latex free air cushion that conforms to facial contours
- One-way valve with anti-viral filter to prevent cross-contamination
- Comes in hard shell storage case



*LifeMask is a registered trademark of CFT, Inc.

Cotton Gait Belt with Metal Buckle

Model : **621**

- Used for mobilizing and transferring patients
- Made of 100% cotton with a metal buckle (58" length)



Stripes - Hot Pink

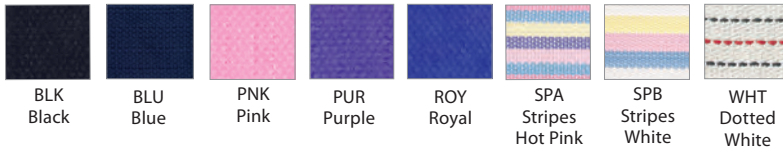

Long Cotton Gait Belt

Model : **621L-WHT**

- 100% cotton belt with a metal buckle (72" length)



Cotton Gait Belt with Plastic Buckle

Model : **620-WHT**

- Same features as model 621, but with a quick release plastic buckle



Nylon Gait Belt

- Used for mobilizing and transferring patients
- Made of heavy duty nylon (58" length)

622 Plastic Buckle
623 Metal Buckle

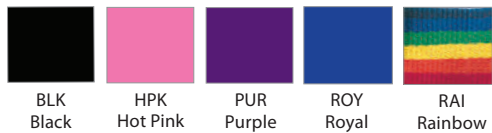

622-HPK



623-RAI

Medical Tourniquet

Model : **4350**

- One-hand operation with a quick release buckle
- Latex free and autoclavable



ROY - Royal

TRO - Tropical

RAI - Rainbow

Anatomy Dissection Kit

Model: **AK-1**

The AK-1 is our deluxe style dissection kit. It comes in a velour lined zippered carrying case (**AK-CASE**) and includes:

- 265** Two Straight Teasing Needles with Handles
- 1560** 5½" Thumb Dressing Forceps
- 1480** 4½" Sharp Splinter Forceps
- 148** 4½" Iris Scissor
- 158** 5½" Dressing Scissor (sh/sh)
- 292** Magnifying Glass
- 1495** Huber Mall Probe
- 264** Fish Hooks (3 Pack)
- 274** S/S Scalpel Handle (No. 4)
- 273** S/S Scalpel Handle (No. 3)
- 278-21** Two Scalpel Blades (No. 21)
- 278-10** Scalpel Blade (No. 10)



Standard Dissection Kit

Model: **DK-1**

An upgraded version of the VK-1. The DK-1 features a hard plastic organizer case (**DK-CASE**) with fitted slots to protect the instruments. Kit includes:

- 265** Two Straight Teasing Needles with Handles
- 147** Student Dissecting Scissor
- 294** Glass Medicine Dropper
- 1490** 4½" Thumb Dressing Forceps
- 273** S/S Scalpel Handle (No. 3)
- 278-10** Scalpel Blade (No. 10)
- 299** Set of Six Dissecting Pins
- 295** Clear Plastic Ruler



Student Dissection Kit

Model: **VK-1**

Ideal for dissection classes, all of the VK-1 components come in a tri-fold eyeglass-style case (**VK-CASE**). Kit includes:

- 265** Two Straight Teasing Needles with Handles
- 294** Glass Medicine Dropper
- 1560** S/S 5½" Thumb Dressing Forceps
- 147** Student Dissecting Scissor
- 273** S/S Scalpel Handle (No. 3)
- 278-10** Scalpel Blade (No. 10)
- 299** Set of Six Dissecting Pins
- 295** Clear Plastic Ruler



Lister Bandage Scissors

Made of stainless steel. Slide pack packaging.

For unpackaged instruments append a "1" to the front of the style number.

Example : **33** Packaged
133 Unpackaged

- 33** 3½" Bandage
- 41** 4½" with Tensionrite™ Clip
- 42** 4½" Gold Plated Bandage
- 43** 4½" Bandage
- 44** 4½" with Large Ring
- 51** 5½" with Tensionrite™ Clip
- 52** 5½" Gold Plated Bandage
- 53** 5½" Bandage
- 53SR** 5½" Bandage - Serrated
- 54** 5½" with Large Ring
- 60** 5½" Left-Handed Bandage
- 73** 7¼" Bandage with Large Ring
- 73SR** 7¼" Bandage - Serrated

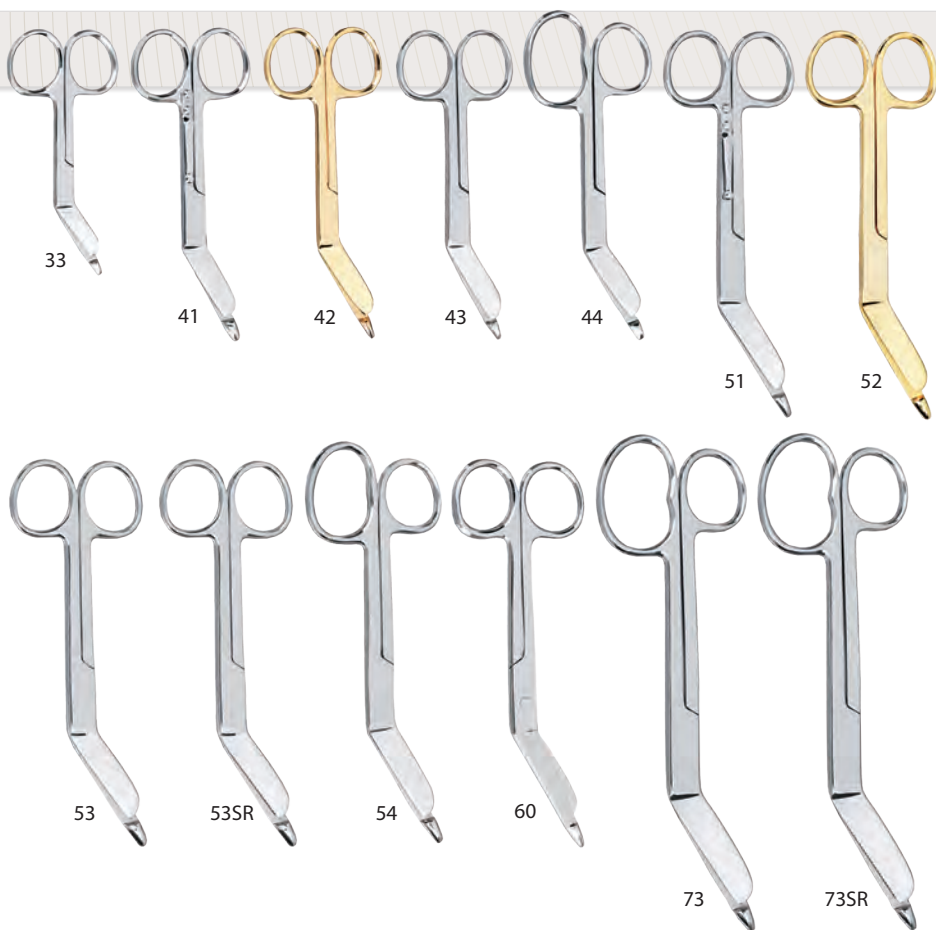

Dressing Scissors

Made of stainless steel. Slide pack packaging.

For unpackaged instruments append a "1" to the front of the style number.

- 55** 5½" Dressing Curved
- 57** 5½" Dressing (sh/bl)
- 58** 5½" Dressing (sh/sh)
- 59** 5½" Dressing (bl/bl)

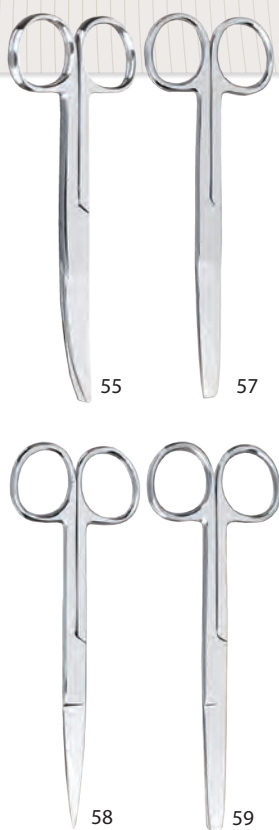

Specialty Scissors

Made of stainless steel. Slide pack packaging.

For unpackaged instruments append a "1" to the front of the style number.

- 48** 4½" Iris
- 50** 5½" Stitch
- 56** 5½" Metzemaum
- 65** 5½" Mayo Dissecting

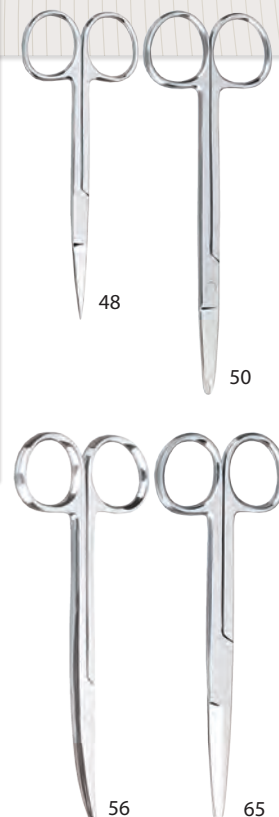

Kelly Forceps

Made of stainless steel. Slide pack packaging.

For unpackaged instruments append a "1" to the front of the style number.

- 530** 3½" Mosquito
- 500** 5½" Kelly (straight)
- 501** 5½" Kelly (curved)
- 502** 5½" Gold Plated Kelly
- 510** 5½" Crile (straight)
- 520** 5" Halstead Mosquito



Specialty Forceps / Probe

Made of stainless steel. Slide pack packaging.

For unpackaged instruments append a "1" to the front of the style number.

- 481** 3½" Micro Point
- 480** 4½" Splinter (sharp)
- 485** 4½" S/S Tissue
- 490** 4½" Thumb Dressing
- 560** 5½" Thumb Dressing
- 482** 4½" Magnifying Splinter
- 503** 5½" Olsen-Hegar Needle Holder / Scissor
- 495** Huber Mall Probe

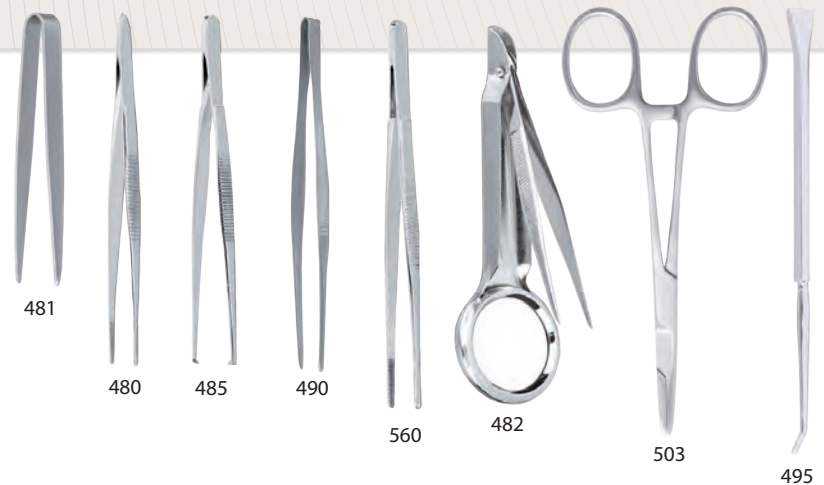

GripMate™ Lister Bandage Scissors

- Traditional Lister bandage scissor design
- Serrations in the handle are perfect for gripping or twisting
- Hook for opening injection (lidocaine) vials
- Stainless steel
- Autoclavable (143°C / 290°F)

- 84** 5½" Bandage Scissor
- 94** 7½" Bandage Scissor



5½" Premium Lister Bandage Scissor

Model : **505** (Box)

- Traditional Lister bandage scissor design
- Made from 420 surgical-grade stainless steel
- Autoclavable
- Five Year Warranty



5½" ListerMate® Bandage Scissor

Model : **853** (Slide Pack)

- Traditional Lister bandage scissor design
- Exclusive molded plastic handles in an assortment of colors
- Stainless steel blades
- Autoclavable (143°C / 290°F)



Solids:



7½" EMT Utility Scissor

Model : **87** (Slide Pack)

- Designed to cut through clothing or bandages
- Made from 420 surgical-grade stainless steel
- Milled shear serrations
- Autoclavable (143°C / 290°F)



Solids:

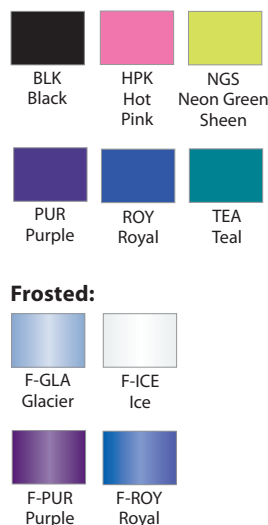

Frosted:



5½" ColorMate™ Kelly Forceps

Model : **504** (Slide Pack)

- Features a Kelly forceps design
- Color-dipped handles
- Stainless steel
- Autoclavable

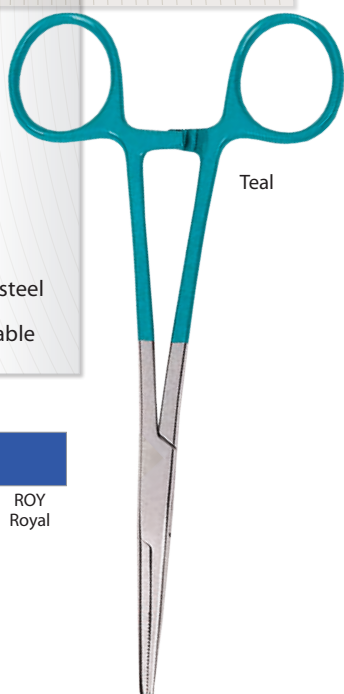

Solids:

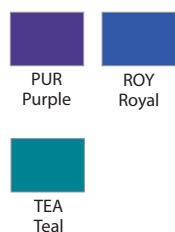

5½" Nurse Utility Scissor

Model : **870** (Slide Pack)

- Same features as the 87 scissor but with a 5½" handle.



Solids:



Frosted:

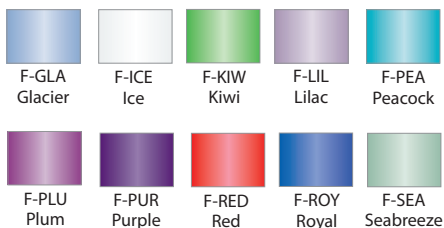

7½" Premium Fluoride Scissor

Model : **607** (Box)

- Fluoride coating provides non-stick surface for cutting tape or bandages
- Made from 420 surgical-grade stainless steel
- Milled shear serrations
- Autoclavable (143°C / 290°F)
- Five Year Warranty



Neon Green

Solids:

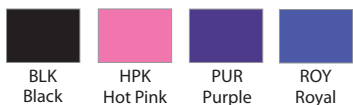

Neon Colors:



5½" Premium Fluoride Scissor

Model : **605** (Box)

- Same features as the 607 scissor but with a 5½" handle.



Neon Pink

Solids:



Neon Colors:



5½" StyleMate™ Utility Scissor

Model : **871** (Slide Pack)

- Our unique cuff prints coated on the scissor blades
- Made from 420 surgical-grade stainless steel
- Milled shear serrations
- Autoclavable (143°C / 290°F)



FSH
Four
Square
Hearts

PHB
Pink
Hearts
Black

LAB
Love
and
Believe*

PRB
Pink
Ribbons
Black*

DAS
Simple
Daisies

*A portion of the sale of all pink ribbon items is donated to the American Cancer Society.

Apparel & Accessories

- 63 Scrubs
- 64 Lab Coats & Jackets
- 65 Socks
- 68 Eyewear
- 70 Organizers & Holsters
- 74 Bags & Totes
- 76 Pens
- 77 Lanyards & ID Holders
- 80 Gifts & Accessories
- 83 Watches
- 87 Professional Jewelry



Premium Five Pocket Unisex Scrubs

Sizes : **XS - 5X***

Unisex scrubs by Prestige Medical® provide all-day comfort with our special "sueded" polyester/cotton blend. Fashionable V-neck top features a single breast pocket and two deep front pockets. Scrub pant features a drawstring waist and a back pocket with a side cargo pocket.

302 - Tops

401 - Pants



Ciel



Grape

Lab Coats

Sizes : **XS - 3X***

Our long length lab coats feature a button front with a faux back belt, three roomy patch pockets and side openings for easy pant access. 65% polyester / 35% cotton.

5710 - Mens
XS not available

5720 - Womens



Consultation Jackets

Sizes : **XS - 3X***

Prestige Medical consultation jackets feature one breast pocket, two front pockets and two interior pockets. Practical for both the lab and office. 65% polyester / 35% cotton.

5730 - Mens
XS not available

5740 - Womens



Non-Slip Compression Socks - Three Packs

Model : **382**

Features a unique patterned non-slip bottom for added safety. Made of 65% nylon and 35% lycra spandex. 10 mmHg. 12" in length.



PFD
Paw Prints, Flowers
and Dots

WHT
White wth
Grey Dots

BLK
Black with
White Dots

Pink Ribbon Compression Socks - Single Pairs

Model : **386***

Made of 65% nylon and 35% lycra spandex. 15-18 mmHg. 12" in length.



PRP
Pink Ribbons
on Pink



PRW
Pink Ribbons
on White

Nurse Compression Socks

Made of 65% nylon and 35% lycra spandex. 10 mmHg. 12" in length.

397 Single Pack
380 3 Pack



Nurse Compression Socks (9" Length) - Single Pairs

Model : **396-WHT**

A 9" version of our compression sock. Made of 65% nylon and 35% lycra spandex. 10 mmHg. Single pairs only. White only.



*A portion of the sale of all pink ribbon items is donated to the American Cancer Society.

Fashion Nurse Socks - Three Packs

Model : 380

Made of 80% cotton, 15% nylon, and 5% spandex. Three per pack.



AUT -
Autism



FSH -
Four
Square
Hearts



HCB -
Neon Heart,
Caduceus,
& Pink Ribbon*



LAB -
Love &
Believe*



PAW -
Paw
Prints



MES -
Medical
Symbols

Fashion Nurse Socks - Single Pairs

Model : 377

Made of 80% cotton, 15%
nylon, and 5% spandex.
One pair per pack.



CAN -
Colored
Alphabet Nurse



HRB -
Heartbeat
EKG

Fashion Nurse Socks - Three Packs

Model : **380** (Continued)



SHA -
Stethoscope
Hearts in
Colors



SHW -
Stethoscope
Hearts in
White



HRB -
Heartbeats
EKG



NHB -
Neon
Hearts
Believe

Neon Nurse Socks - Three Pack

Model : **383-PGY**

Made of 95% acrylic and 5% lycra spandex. Three colors per pack. Neon pink, neon green, and neon yellow.



Basic Ankle Socks

Model : **355-WHT**

Made of 95% cotton and 5% lycra to ensure comfort and maintain shape.



Moisture Wicking Socks

Model : **381-WHT**

Anti-microbial moisture wicking socks designed to keep feet dry. Made of 90% polypropylene, 7% nylon, and 3% lycra spandex.



Colored Temple Eyewear

Model : 5300

Anti-scratch, anti-fog, anti-static
Polycarbonate lenses that meet
ANSI Z87.1 standards and
protect against UV rays.



Neon
Pink

Solids:



Neon:

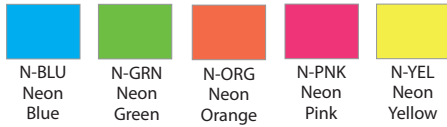

Frosted:

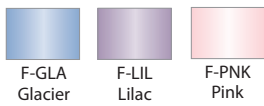

Colored Full Frame Adjustable Eyewear

Model : 5400

Anti-scratch, anti-fog, anti-static
Polycarbonate lenses that
meet ANSI Z87.1 standards
and protect against UV rays.

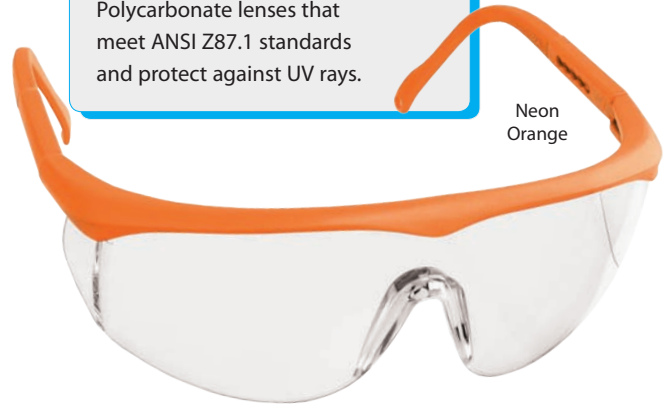

Neon
Orange

Solids:



Neon:

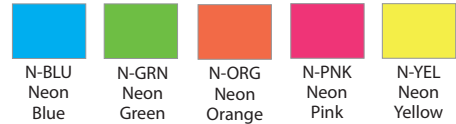

Frosted:

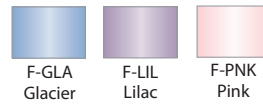

Printed Full Frame Adjustable Eyewear

Model : 5420

Anti-scratch, anti-fog, anti-static Polycarbonate lenses that
meet ANSI Z87.1 standards and protect against UV rays.
Adjustable temples.



Rose

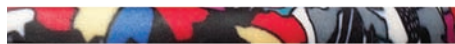

ABS
Abstract

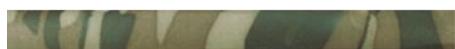

CAM
Camouflage



FES
Festival



ROS
Rose



TUT
Tutti Frutti



ZEB
Zebra

Small Frame Designer Eyewear

Model : **5440-BLU**

Anti-fog, anti-static and anti-scratch Polycarbonate lenses. Meets ANSI Z87.1 standards. Adjustable temples with blue frames.



Splash Goggles

Model : **5600**

Fog resistant, meets ANSI Z87.1 standards, Designed to protect the wearer from liquid splash by using covered vents.



Visitor / Student Glasses

Model : **5900**

Made in USA by Uvex and designed for general use. Fixed side shields for improved protection.



Cap Case

Model : **15**

A specially designed storage case for nurse caps. Keeps caps professionally white and clean. Cap not included.

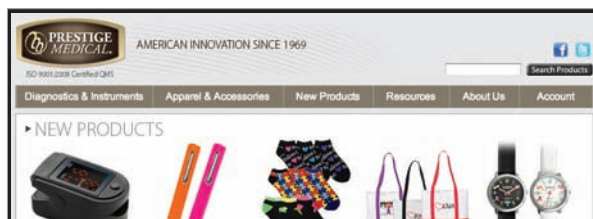

Visit our website to stay updated on New Products that we introduce throughout the year. www.prestigemedical.com

Belt Loop Organizer Kit

Features four front pockets, including a “hook-and-loop” closure coin pocket, key chain clip and matching color tabs to secure instruments. Loop on the back fits most belts. Comes with a 5½” Lister bandage scissor, disposable penlight and 4-color chart pen.

- | | |
|------------|------------------------|
| 731 | Full Kit |
| 730 | Organizer Only (Empty) |

Organizer Colors:



Purple

Belt Loop Organizer DX™ Kit

Model : **736**

Features four front pockets, including a “hook-and-loop” closure coin pocket, key chain clip and matching color tabs to secure instruments. Loop on the back fits most belts. Comes with a 5½” Lister bandage scissor, 5½” Kelly forceps, disposable penlight and 4-color chart pen.

Organizer Colors:



Pink

Belt Clip Organizer Kit

Features four front pockets, a “hook-and-loop” closure coin pocket, key chain clip and matching color tabs to secure instruments. Plastic clip on the back fits any belt or waistband. Comes with a 5½” Lister bandage scissor, disposable penlight and 4-color chart pen.

- | | |
|------------|------------------------|
| 733 | Full Kit |
| 732 | Organizer Only (Empty) |

Organizer Colors:



Back Clip



Navy

5-Pocket Organizer Kit

Features four front pockets, including a "hook-and-loop" closure coin pocket, key chain clip and matching color tabs to secure instruments. Also contains a pocket on the back. Comes with a 5½" Lister bandage scissor, disposable penlight and 4-color chart pen. Available in three prints or white (blank).

- 741** Full Kit
- 740** Organizer Only (Empty)

Organizer Prints:



DAS
Daisy
on White

DSB
Daisy
on Black

HPR
Hope
Pink Ribbon*

WHT
White
(Blank)



Daisy on White

5-Pocket Utility Organizer Kit

Model : **742**

A white (blank) 5-Pocket Organizer with key chain clip and "hook-and-loop" tabs to secure instruments. Comes with a 5½" Utility scissor, a color-matched disposable penlight and 4-color chart pen.

Scissor / Penlight Colors:

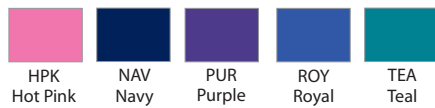

HPK
Hot Pink

NAV
Navy

PUR
Purple

ROY
Royal

TEA
Teal



Royal

5-Pocket Designer Organizer Kit

Model : **742**

A special printed version of our 5-Pocket Utility Organizer Kit. Key chain clip and "hook-and-loop" tabs to secure instruments. Comes with a 5½" Utility scissor, matching disposable penlight and 4-color chart pen.

Organizer Prints with Scissor / Penlight Colors:



DAS
Daisy on White
with Black Scissor
and Penlight

HPR
Hope Pink Ribbon
with Hot Pink Scissor
and Penlight*



Hope Pink
Ribbon with
Hot Pink

Horizontal Belt Leather Holster Set

Model : **K772**

Constructed of full grain leather. Affixes to a belt horizontally using two back belt loops with snaps. Features a large pocket and a small pocket with a "hook-and-loop" closure strap for securing instruments.

Set includes:

- 7½" EMT utility scissor
- QuickLite™ penlight

K772 Full Set
772 Holster Only



Square Padded Leather Holster Set

Model : **K775**

Constructed of full grain leather. Five pocket design. Features a snap-closure pocket. Affixes to a belt vertically using a back belt loop with snaps.

Set includes:

- 7½" EMT utility scissor
- 5½" Kelly forceps
- 5½" thumb dressing forceps
- QuickLite™ penlight
- Buck Knife

K775 Full Set
775 Holster Only



Horizontal Belt Nylon Holster Set

Model : **K773**

Constructed of heavy duty nylon. Affixes to a belt horizontally using two back belt loops with snaps. Features a large pocket and a small pocket with a "hook-and-loop" closure strap for securing instruments.

Set includes:

- 7½" EMT utility scissor
- QuickLite™ penlight

K773 Full Set
773 Holster Only



Square Padded Nylon Holster Set

Model : **K765**

Constructed of heavy duty padded nylon. Five pocket design. Features a "hook-and-loop" closure front flap to secure instruments. Affixes to a belt vertically.

Set includes:

- 7½" EMT utility scissor
- 5½" Kelly forceps
- 5½" thumb dressing forceps
- QuickLite™ penlight
- Buck Knife

K765 Full Set
765 Holster Only



Large Organizer Belt

Model : 752-BLK

Large nylon organizer belt. Features two tape loops, ten pockets, three "hook-and-loop" closure tabs, quick release buckle, and 50" adjustable belt. Dimensions: 19" x 8¼". Black only.



Organizer Belt

Model : 652

Features one tape loop, seven pockets, two "hook-and-loop" closure tabs, quick release buckle, and 50" adjustable belt. Dimensions: 8" x 8¼".



BLK
Black

NAV
Navy

WHT
White

Compact Carry Case

Model : 745

6" x 9" nylon zippered carry case. "Hook-and-loop" closure side pocket. Ideal for storing instruments and accessories.



Solids:



Prints:



Ribbons & Hearts Purple

*A portion of the sale of all pink ribbon items is donated to the American Cancer Society.

Large Tote Bag

Model : 705

Made of durable canvas with a water-resistant lining. Features a "hook-and-loop" closure top, key fob and inside pocket.

Dimensions: 12" x 14"x 2".

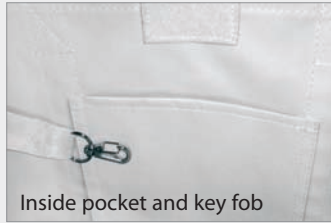

Inside pocket and key fob



BHH
Betty Boop® Hearts



STG
Stick Nurse on Grey



RNR
RNA on Red



RNB
RN on Black



PRH
Pink Ribbon Hope*



CNR
CNA on Red



CNB
CNA on Black



NTB
Nurse Trio on Black



NTG
Nurse Trio on Grape



NTP
Nurse Trio on Pink

Nurse Car-Go™ Bag

Model : 771

The Car-Go™ utility bag is designed for the traveling or homecare nurse. Features include a travel mug holder, front mesh pouch, cell phone pouch, removable aneroid sphygmomanometer compartment and a bottom "hook-and-loop" closure strip holds the bag in place on cloth seats or floor. Multiple inner compartments hold additional equipment and personal effects.

Dim: 13" x 6" x 4"



Padded Medical Bag

Model : 753

Specifically designed to hold medical instruments and fully lined with water-resistant nylon and protective padding. Features multiple inner pockets and zippered compartments to enable easy storing and securing of instruments. Other features include two exterior compartments, an adjustable shoulder strap, and a heavy duty handle. Dim: 11" x 9" x 5".



Custom Patches

Prestige Medical specializes in custom medical patches in a wide range of styles.

Please contact customer service for details.



Visit our website to stay updated on New Products that we introduce throughout the year. www.prestigemedical.com

Breast Cancer Awareness Rope Pens*

Plastic pen with a heavy-duty white rope and breakaway clasp.

343 Poly Bag
343-AST Assorted Cylinder (20)



HRP Hope Pink Ribbon
 BRH Believe and Love
 PHB Believe with Hearts
 HBL Hope, Believe, Love
 WBH Believe with Hearts

Pink Ribbon Rope Pen

Model : 333*

Plastic pen with a heavy-duty white rope and breakaway clasp.

HPR Poly Bag
CYL Cylinder (20)



Betty Boop® Nurse Rope Pens

Model : 339

Plastic Betty Boop® Nurse pens with a heavy-duty white rope and breakaway safety clasp.



BOT Bottoms Up
 LUV Love A Nurse

Fashion Print Rope Pens

Model : 337

Plastic pens with a heavy-duty rope and breakaway safety clasp.



LAB Love and Believe*
 FSH Four Square Hearts
 PNT Paint Splatter

Four-Color Chart Pen

Plastic pen with black, blue, green, and red ink. Features a "no-slip" grip and pocket clip.

401 Poly Bag
S401 Slide Pack
401-CYL Cylinder (30)



Liquid Syringe Pen

Model : 348

Red liquid with black ink in a fun syringe pen.

Counter Display of 60 Pens



Syringe Highlighter

Model : 349

Highlighter marker in a fun syringe design. Protective cap included.

Cylinder of 18



Printed Lanyard

Model : 6033

Made of soft polyester. Features a breakaway safety clasp and bulldog clip.



Retractable Lanyard

Model : 6053

Detachable Retracteze™ on a lanyard with quick release buckle. Extends up to 23". Includes breakaway safety clasp.

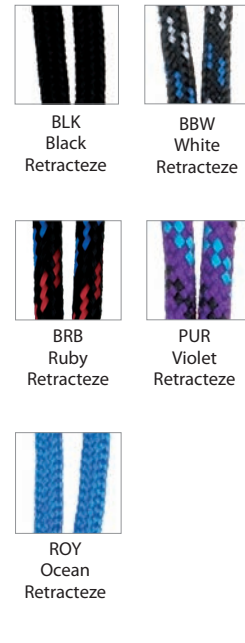

Basic Lanyard

Model : 6045

Standard metal badge holder with a durable bulldog clip and a break-away clasp.



Purple

Neon Lanyard

Model : 6046

Standard metal badge holder with a durable bulldog clip and a break-away clasp.



Neon Green

Clip Lanyard

Model : 6051

Quick release buckle with a metal bulldog clip. Includes a breakaway safety clasp and extra-wide fabric for comfort.

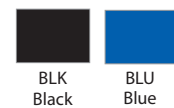

Blue

Retracteze™ ID Holder

Model : S13

Retracteze™ ID badge holders extend to 23". A metal clip on back enables easy fastening to apparel. The button-snap ID holder can also hold keys.



OCE
Ocean



VIO
Violet

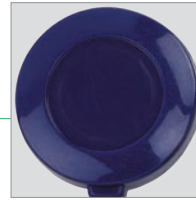

ROY
Royal



RUB
Ruby



BLK
Black



WHT
White



SVR
Silver



EKG
EKG Heart



N-BLU
Neon Blue



N-GRN
Neon Green



N-ORG
Neon Orange



N-PNK
Neon Pink



N-YEL
Neon Yellow



BFY
Butterflies



PRH
Pink Ribbon Heart*



PRN
Pink Ribbon RN*



CBB
Love a CNA



HBB
Hearts



PRB
Pink Ribbons Black*



FLN
Frog (Love a Nurse)



PLN
Panda (Love a Nurse)



GWB
Get Well

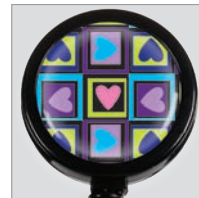

FSH
Four Square Hearts

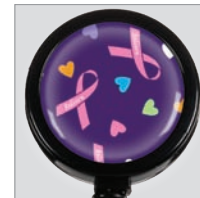

LAB
Love and Believe*

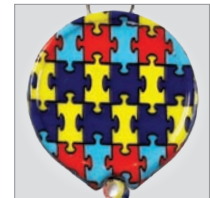

AUT
Autism

Retracteze Reel Deal™ Countertop Displays

Countertop display includes 60 ID Holders. Individually packaged in poly bags.

- DIS-13** Assorted designs (neon excluded)
- DIS-N-13** Assorted neon colors only



Deluxe Retracteze™ ID Holder

Model : **S14**

Deluxe 3-D ID badge holders extend to 23". Bulldog-style clip on back allows easy fastening to apparel. The button-snap ID holder can also hold keys.

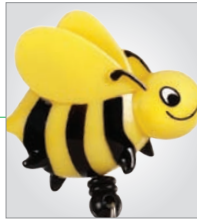

Bee
Bee



BUG
Lady Bug



BTF
Butterfly



CAT
Cat



DAS
Daisy



DOG
Dog



FRG
Frog



MON
Monkey



OWL
Owl



YDK
Yellow Duck

Premium All Metal Retracteze™ ID Holder

Model : **S15**

All metal ID badge holder. Metal cord extends to 24". Metal clip on back enables fastening to apparel. The button-snap ID holder can also hold keys.



Standard ID Holder

Model : **16**

A standard ID holder with a back bulldog clip for easy fastening to apparel or layards.



Magnetic ID Holder

Model : **18**

A standard ID holder with a two-piece magnetic back for easy fastening.



Leather ID Pouch

Model : **19-BLK**

Genuine leather pouch with ID window. Features include a zippered coin compartment and a lanyard with breakaway safety clasp. Black only.



Two Way ID Holder

Model : **12**

Displays vertically or horizontally using a detachable button snap.



Tape Measure

Model : **45**

Measures in inches (60") and centimeters (150cm).



Heart Key Chain Tape Measure

Model : **KT-45**

Heart-shaped tape measure with key chain and caribiner. Measures in inches (60") and centimeters (150cm).

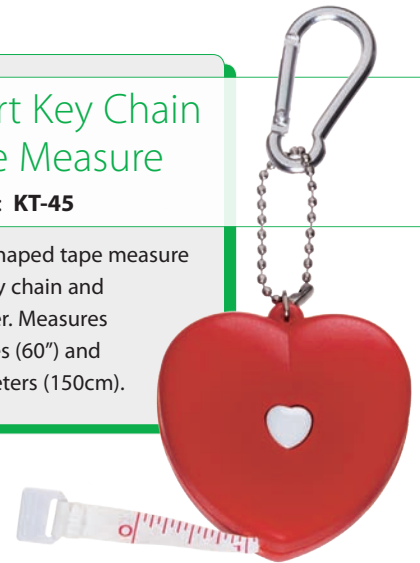

Character Key Tags

Model : **KT**

Made of Soft Silicone with a key ring. Ave Dim: 3" x 1 1/2". Latex free.



BHB
Betty Boop®
Too Hot

HPR
Hope Pink
Ribbon*

DTN
Dotty Nurse

Dr. Scrubz Bear

Model : **1841-TEA**

Measures 10" tall. Comes wearing teal scrubs with a matching scrub mask and cap.



Patient Bear

Model : 1849

Measures 9" tall.
Comes wearing a white t-shirt with a fabric leg cast, bandage, and crutch.



Graduation Bear

Model : 1923

Measures 8" tall. Comes wearing cap, gown, and holding a rolled diploma.



Ceramic Graduation Lamp

Ceramic Florence Nightingale lamp with candle. Available in two sizes.

Large Dimensions : 3¼" x 6¼".
Small Dimensions : 2½" x 2½".

1890 Large lamp

1891 Small lamp



Battery Operated Ceramic Graduation Lamp

Model : 1897

Large ceramic Florence Nightingale lamp with a battery operated candle. AAA battery included. Dimensions: 3¾" x 6¾".

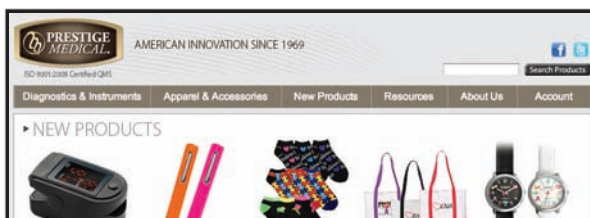

Visit our website to stay updated on New Products that we introduce throughout the year. www.prestigemedical.com

Bringing the
instruments of
healthcare to life



Professional Watches

Specially crafted for medical professionals, Prestige Medical time pieces are designed for a variety of workplace applications while enabling the personalization of the instruments of healthcare. All analog watches are quartz movement with a battery included (SR626SW).

Cyber Gel™ Scrub Watch

Model : 1777

Silicone band. Plastic case. Plastic lens. 5 colors to choose from.



SportMate™ Scrub Watch

Model : 1888

Silicone band. Plastic case. Plastic lens. 8 colors to choose from.



Basic Scrub Watch

Model : **1770-WHT**

Silicone band.
Plastic case.
Plastic lens.



Student Scrub Watch

Model : **1769-WHT**

Plastic band.
Plastic case.
Plastic lens.



Pink Ribbon Scrub Watch

Model : **1773-PR***

Translucent plastic band and case.
Plastic lens.



Braided Scrub Watch

Model : **1889-HPK**

Silicone band.
Plastic case.
Plastic lens.



Easy Reader Watch

Model : **1736**

Leather band.
Chrome case.
Glass lens.



Medical Symbols Watch

Model : **1799***

Leather band.
Chrome case.
Glass lens.
Available in either black or white.



BLK

WHT

Braided Band Fashion Watch

Model : 1778

Silicone band.
Chrome case.
Glass lens.
6 colors to choose from.



Deluxe Classic Watch

Model : 1756*

Leather band.
Chrome case.
Glass lens.
Available in black or with a pink ribbon on the face.



Classic Watch

Model : 1700

Leather band.
Chrome case.
Glass lens.



Glow-Face Watch

Model : 1711

Leather band.
Chrome case.
Glass lens.
Features a glow-in-dark face.



Electro-Light™ Watch

Model : 1686

Leather band.
Chrome case.
Glass lens.
Features a push-button glow face.



Woven Leather Fashion Watch

Model : 1779*

Braided leather band. Chrome case.
Glass lens. Available in purple, hot pink or a pink ribbon design.



PUR
Purple



HPK
Hot
Pink



PR
Pink
Ribbon

Expansion Band Watch

Model : 1631

Chrome band. Chrome case. Glass lens. Features an elastic expansion band to fit any wrist.



Link Lapel Watch

Model : 1740

Bracelet band. Chrome case. Glass lens.



Glow-Face Lapel Watch

Model : 1741

Chain band. Chrome case. Glass lens. Glow-in-the-dark face.



Lanyard Watch

Model : 1789-BLK

Black breakaway nylon lanyard. Chrome case. Glass lens.



Insignia Tacs

Plastic clutch back.
Two per package.



90
Caduceus



91
Registered Nurse
Caduceus



92
Licensed Vocational
Nurse Caduceus



93
Licensed Practical
Nurse Caduceus



97
Certified Nursing
Assistant Caduceus



906
Medical
Assistant



910
Registered
Nurse



911
Bachelor of
Science Nursing



920
Licensed
Vocational Nurse



930
Licensed
Practical Nurse



960
Emergency
Medical Technician



975
Certified
Nursing Assistant

Professional Tacs

Plastic clutch back.
One per package.



992
Pink Ribbon*



904
Praying Hands



905
Autism



907
Eye Chart



900
Believe in
Miracles



938
Guardian
Angel



996
Tooth
Character



980
Cardio Pulmonary
Resuscitation



984
Gold Nightingale
Lamp



990
Large Gold
Caduceus

Badge Tacs

Plastic clutch back.
One per package.



9400
Pink Ribbon - Silver*



9392
Pink Ribbon*



9342
Love A Nurse



9346
We Care



9310
Registered Nurse



9326
Certified Nursing Assistant



9330
Licensed Practical Nurse



9314
Guardian Angel



9381
EKG Heart



9382
Registered Nurse



9390
Caduceus Blue

Magnetic Pink Ribbon Badge Tac

Model : 9412*

Two-piece magnetic
back eliminates
piercing of garment.
Crystal studded face.
One per package.



Professional Cloisonné Emblem Pins



Individually handcrafted professional cloisonné emblem pins exhibit an artisan's attention to detail. Cloisonné is an old-world metal working process that utilizes gold or silver wire to create shapes which are then filled with finely ground glass, crystals, or precious metals and fired in a kiln at extremely high temperatures. The result is exquisite beauty and luster which enhances the pride and appearance of any medical professional. All feature a locking pin back. One per package. Listed in alphabetical order.



2080
Advanced Cardiac
Life Support



2089
Anesthesia
Assistant



2011
Bachelor of
Science Nursing



1020
Caduceus



1010
Caduceus
(Filigreed Heart)



1080
Cardio Pulmonary
Resuscitation



1014
Certified
Acupuncturist



1087
Certified Emergency
Medical Technician



1073
Certified Medical
Assistant



1074
Certified Medical
Assistant



1076
Certified
Nurses Aide



1071
Certified Nursing
Assistant



1075
Certified
Nursing Assistant



2075
Certified Nursing
Assistant, Level II



1062
Certified Occupational
Therapy Assistant



1037
Certified Pharmacy
Technician



1009
Certified Registered
Nurse Practitioner



1096
Dental
Assistant



1090
Emergency
Medical Technician



1086
Emergency Medical
Technician



2087
Emergency
Medical Technician



1091
First
Responder



1015
Holistic
Medicine



1072
Licensed
Nursing Assistant



1023
Licensed
Practical Nurse



1013
Licensed
Practical Nurse



1033
Licensed
Practical Nurse



1053
Licensed
Practical Nurse



1022
Licensed
Vocational Nurse



1012
Licensed
Vocational Nurse



1032
Licensed
Vocational Nurse



1042
Licensed
Vocational Nurse



1008
Massage
Therapist



2020
Master of Science
Nursing



1006
Medical
Assistant



2021
Nurse
Practitioner



1007
Nursing
Assistant



1084
Paramedic



1038
Patient Care
Assistant



2024
Patient
Service Worker



1016
Pediatric Advanced
Life Support



1035
Pharmacist Rx



1046
Pharmacist Rx



2035
Pharmacy
Technician



1058
Phlebotomy
Technician



2025
Physical Therapist
Assistant



1089
Registered Dental
Hygienist



1066
Registered
Medical Assistant



1021
Registered
Nurse



1011
Registered
Nurse



1001
Registered
Nurse



1031
Registered
Nurse



1017
Registered
Nurse Practitioner



2023
Registered
Practical Nurse



1051
Registered
Veterinary Technician



1048
Respiratory
Therapist



2012
Star of Life



1093
State Tested
Nursing Assistant



2088
Surgical
Technician



2004
Usher



1049
Veterinary
Medicine



1050
Veterinary
Technician

Custom emblem pins are available, please contact customer service for details.

Merchandise Displays

Rotating Counter Display

Model : **DIS-RR**

Three sides with six rows per side. Warm-grey metal tubing with a natural blonde wood finish.

8½" x 24½"



Countertop Watch Display

Model : **DIS-TB-WATCH**

Made of clear acrylic with a black imprint. Holds 20 watches (toothbrush-style cases).

11.5" x 12" x 9"



Wire Counter Display

Model : **DIS-LAN**

Made of sturdy black wire. Features 4 prongs for displaying socks, lanyards or watches.

12" x 17"



Slat Wall Display Sign

Model : **DIS-SIGN**

Features the Prestige Medical® full-color badge logo. A "Z" hook on the back allows easy installation on any slat wall.

30" x 14"



Do you do Hospital Shows?



Hospital Show Program

1. Please contact our sales department for a “Hospital Show Program Application Form”
2. You must have Net 30 terms to qualify and participants must be in good credit standing at the time an order is placed.
3. We will grant net 60 terms for each purchase order placed for Hospital Shows.
4. You can have only one Hospital Show order open at any given time.
5. Product must be returned in a resalable condition. Meaning no price stickers and packaging is not damaged in any way. If the packaging has been damaged, you will be charged a 15% restocking fee.

Group Orders?



Custom Combination Kits

If you don't see a combination kit that meets your needs, simply create your own. Prestige Medical offers hundreds of possible combinations.

To create your own custom combination kit, please contact customer service or your sales representative.

General Return Policies

To ensure prompt handling of your returns please follow the guidelines below:

- Returns must be sent to us freight pre-paid
- No returns without prior authorization
- The name and address of your store must be enclosed inside the box
- Written reason for the return must also be enclosed inside the box

Our returns department will make a determination of whether to issue credit, replace or repair. We also reserve the right to deduct a 15% restocking charge.

Pink Ribbon Merchandise

A portion of the sale of all “Pink Ribbon” merchandise is donated to the American Cancer Society.

3M Littmann® Stethoscopes Return Policy

If a Littmann® stethoscope or replacement part is damaged upon receipt of your order, you may return it directly to Prestige Medical®. If you have SOLD a Littmann stethoscope or replacement part to a customer (or end user), it MUST be returned by the end user directly to Littmann®.

Littmann Repairs & Refurbishing: **(800) 292-6298** • Littmann Manufacturing Defects: **(800) 228-3957**

The Prestige Medical Website

www.prestigemedical.com

Please visit us online today. All of our diagnostic instruments can be viewed in each of their unique color offerings by scrolling over the associated color swatches. We continue to enhance and improve the online shopping experience for our dealers to make it quicker and easier than ever to place purchase orders online at any time.

Like Us on Facebook
and Follow us on Twitter.

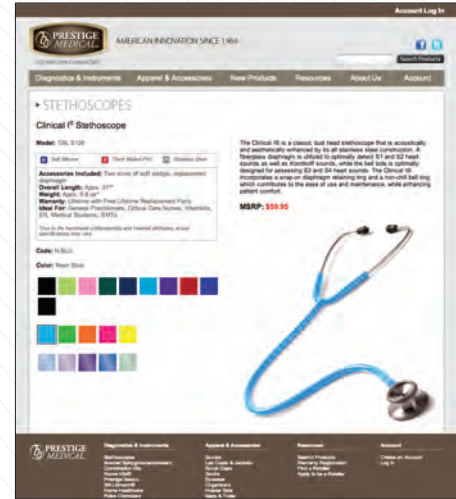

Unisex Scrubs Sizing Guide

Measurements are actual body measurements (in inches). Garment measurements will be larger to allow for ease of movement.

	XS	S	M	L	XL	2X	3X	4X	5X
CHEST	32" – 34"	35" – 37"	38" – 40"	42" – 44"	46" – 48"	50" – 52"	54" – 56"	58" – 60"	62" – 64"
WAIST	24" – 26"	27" – 29"	30" – 32"	34" – 36"	38" – 40"	42" – 44"	46" – 48"	50" – 52"	54" – 56"
HIP	32" – 34"	35" – 37"	38" – 40"	42" – 44"	46" – 48"	50" – 52"	54" – 56"	58" – 60"	62" – 64"
<i>Unisex inseams are approximately 31 inches</i>									

Men's Lab Coats & Consultation Jackets Sizing Guide

Measurements are actual body measurements (in inches). Garment measurements will be larger to allow for ease of movement.

	S	M	L	XL	2X	3X
CHEST	35" – 37"	38" – 40"	42" – 44"	46" – 48"	50" – 52"	54" – 56"
WAIST	27" – 29"	30" – 32"	34" – 36"	38" – 40"	42" – 44"	46" – 48"
HIP	35" – 37"	38" – 40"	42" – 44"	46" – 48"	50" – 52"	54" – 56"
<i>Men's inseams are approximately 31 inches</i>						

Women's Lab Coats & Consultation Jackets Sizing Guide

Measurements are actual body measurements (in inches). Garment measurements will be larger to allow for ease of movement.

	XS	S	M	L	XL	2X	3X
BUST	33" – 34"	35" – 36"	37" – 39"	40" – 43"	44" – 47"	48" – 51"	52" – 55"
WAIST	24" – 25"	26" – 27"	28" – 30"	31" – 34"	35" – 38"	39" – 42"	43" – 46"
HIP	35" – 36"	37" – 38"	39" – 41"	42" – 45"	46" – 49"	50" – 53"	54" – 57"
<i>Women's inseams are approximately 30 inches</i>							

Prints for Blood Pressure Cuffs and Carry Cases



BCH
Betty Boop Colored Hearts



FSH
Four Square Hearts



HPH
Hot Pink Hearts



LAB
Love and Believe



NGD
Night Garden



OBK
Owls Black



OCM
Owls Cream

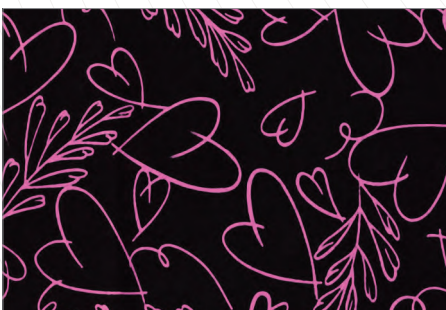

PHB
Pink Hearts Black



PRB
Pink Ribbons Black



RPK
Ribbons and Hearts Pink



RPU
Ribbons and Hearts Purple

To view virtual product samples in their respective colors and prints, please visit us online at:

www.prestigemedical.com

INDEX

Aneroid Sphygmomanometers	28–40, 43–44, 47	Jewelry	87–89
Aneroid Sphygmomanometer Kits	36–40, 43–44	Key Tags	80
Apparel	62–67	Lab Coats	64
Apparel Sizing Guides	92	Lanyards	77
Badge Holders	78–80	Littmann® Stethoscopes and Products	24–27
Badge Tacs	87	Measuring Tools	54–55
Bags (Doctors / Nurses)	74–75	Medimeter™	54
Basics (Stethoscopes, Aneroids, Kits)	42–44	Merchandise Displays	90
Bears (Plush Gifts)	80–81	Nurse Kits®	38, 41
Cap Case	69	One-Hand Aneroid Sphygmomanometers	35
Carry Cases	73	Online Ordering	92
Clear Sound Stethoscopes	16–17	Organizers	70–73
Clinical Series Combination Kits	36–38	Otoscopes	51
Clinical Series Stethoscopes	4–11	Patches (Custom)	75
Clipboard	53	Pedometer	46
Consultation Jackets	64	Pens and Highlighter	76
CPR Masks	55	Penlights	50–51
Custom Combination Kits	91	Pins	88–89
Digital Blood Pressure Monitors	47	Pocket Organizers	70–71
Digital Thermometers	48–49	Prestige Basics (Stethoscopes, Aneroids, Kits)	42–44
Disposable Stethoscope	20	Pulse Oximeters	46
Dissection Kits	57	Retracteze™	78–79
Dual Head Stethoscopes	5, 7–10, 18–19, 42	Rubber Goods	49
Eartips	23, 27	Scissors and Instruments	57–61
EKG Calipers	53	Scrubs	63
EMS (EMT) Products	55–56	Single Head Stethoscopes	6, 11, 16–17, 20
Electronic Stethoscopes	24	Single-Hand Aneroid Sphygmomanometers	35
Emblem Pins	88–89	Socks	65–67
Eye Charts	54	SpragueLite® Stethoscopes	15, 42
Eyewear	68–69	Sprague-Type Stethoscopes	11, 13–15, 42
Forceps / Hemostats	59–60	Stethoscopes	2–27
Gait Belts	56	Stethoscope Accessories	21–22
General Information and Policies	91	Stethoscope Parts	23, 27
Gifts	80–81	Tacs	87
Goggles / Eyewear	68–69	Tape Measures	80
Goniometers	54	Teaching Stethoscopes	9, 14, 27
Graduation Lamps	81	Thermometers (Digital)	58–49
Hammers (Neurological)	52–53	Tote Bags	74
Hip Clip™ (Stethoscope Holder)	22	Tourniquets	56
Holsters	72	Transfer Belts	56
Home Health Products	46–49	Tuning Forks	53
Hospital Show Policy	91	Veterinary Products	45
ID Holders	78–80	Watches	83–86
ID Tags (Stethoscope)	22	Web Ordering	92